

# 20 CATALOG

v20.19.10.21

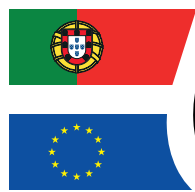

*protection parts*  
**off-road**





Paulo Gonçalves  
Rally Rider

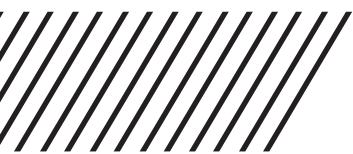

**made by CrossPro**

08

off-road



36

accessories



40

bike stands



44

side by side



64

sports quad



88

utility ATVs

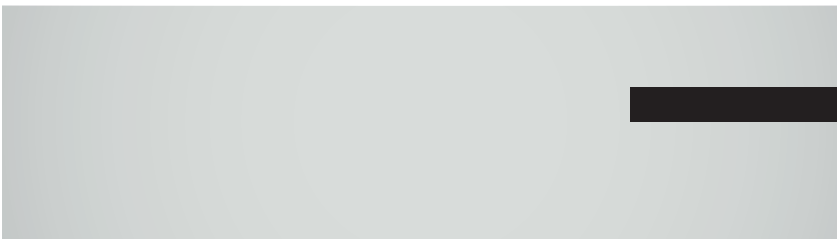

CENTRO 2020 PORTUGAL 2020



UNIÃO EUROPEIA  
Fundo Europeu  
de Desenvolvimento Regional



ride  
and  
enjoy it

05





[www.crosspro.pt](http://www.crosspro.pt)

Em 2005 nasce a CrossPro, uma empresa que se dedica a produção de protecções e acessórios para veículos de 2 e 4 rodas. A paixão e conhecimento dos seus fundadores sobre a modalidade e mecânica, permitiram um rápido e sustentável crescimento da CrossPro.

Rapidamente, a CrossPro alcançou na Europa uma respeitável reputação pela produção e desenvolvimento dos seus produtos, as soluções oferecidas permitiram alcançar novos mercados e actualmente assegurar a presença a nível mundial em mercados muito distintos, mas ao mesmo tempo tão exigentes como o Europeu.

Os nossos produtos são fabricados na nossa unidade fabril em Portugal, sendo submetidos a um rigoroso controlo de qualidade para assegurar a qualidade dos produtos oferecidos. A aposta na melhoria contínua dos nossos produtos e processos, conferem aos produtos que oferecemos uma diferenciação no mercado.

Todos os produtos da CrossPro são submetidos a testes em condições extremas, o que nos permite obter o produto final

adequado ao consumidor final, sendo ele profissional ou amador, garantindo um máxima performance.

Apostamos no aumento da nossa gama, estando atentos as novas tendências dos mercados, procurando antecipar as necessidades dos nossos actuais e potenciais clientes, desenvolvendo novas soluções para estes.

A nossa gama ao longo da nossa existência tornou-se cada vez mais ajustada ao consumidor e as suas exigências, o feedback do cliente ajuda-nos a melhorar e ajustar o produto.

A mudança de instalações em 2017, agora com 5000m2, aliada ao investimento em nova maquinaria (corte a laser, célula de solda robotizada, maquina de lixar por planos, unidade de pintura Eletrostática, entre outras) bem como o *Know-How*, permitiu ainda a CrossPro entrar em novas áreas de negócios, aumentando as nossas valências como metalomecânica e produtores dos mais variados produtos.

CrossPro é sinónimo de qualidade para o cliente.



In 2005 CrossPro was born, a company dedicated to the production of protections and accessories for 2 and 4 wheel vehicles. Their founders' passion and knowledge of the sport and mechanics allowed CrossPro to grow rapidly and sustainably.

CrossPro quickly achieved a respectable reputation in Europe for the production and development of its products, the solutions offered have made it possible to reach new markets and today ensure a worldwide presence in very different markets, but at the same time as demanding as the European market.

Our products are manufactured in our factory in Portugal and are subject to strict quality control to ensure the quality of the products offered. The bet on the continuous improvement of our products and processes, give the products we offer a differentiation in the market. All CrossPro products are tested under extreme conditions, allowing us to obtain the final product suitable for the end consumer, whether professional or amateur, ensuring maximum performance.

We focus on increasing our range, being aware of new market trends, seeking to anticipate the needs of our current and potential customers, developing new solutions for them.

Our range over our lifetime has become increasingly consumer-adjusted and their requirements, customer feedback helps us improve and adjust the product.

The change of installations in 2017, now with 5000 sqm, combined with investment in new machinery (laser cutting, robotic welding cell, flat sanding machine, electrostatic painting unit, among others) as well as Know-How, also allowed CrossPro enters new business areas, increasing our skills as a metalworker and producers of various products.

CrossPro stands for quality.



» **Protect the important with CrossPro**

We offer a wide range in Aluminum and DTC with the best quality, to several models since the oldest to the newest, offering you the best protection to your bike.

Developed using the best raw material and with support of improved production techniques, the CrossPro protections are essential to get the best performance from your bike.

Ride and enjoy it

» **Protege o mais importante com Crosspro**

Dispomos de uma vasta gama em alumínio e DTC com a melhor qualidade, para os mais diversos modelos desde os mais antigos até aos mais recentes, oferecendo-lhe a melhor protecção para a sua moto.

Desenvolvidas com recurso às melhores matérias-primas e com suporte das melhores técnicas de produção CrossPro são uma peça fundamental para usufruir ao máximo da sua moto.

Ride and enjoy it.

**off-road**



09



# NEW 2020

# HARD LINK<sub>DTC</sub>

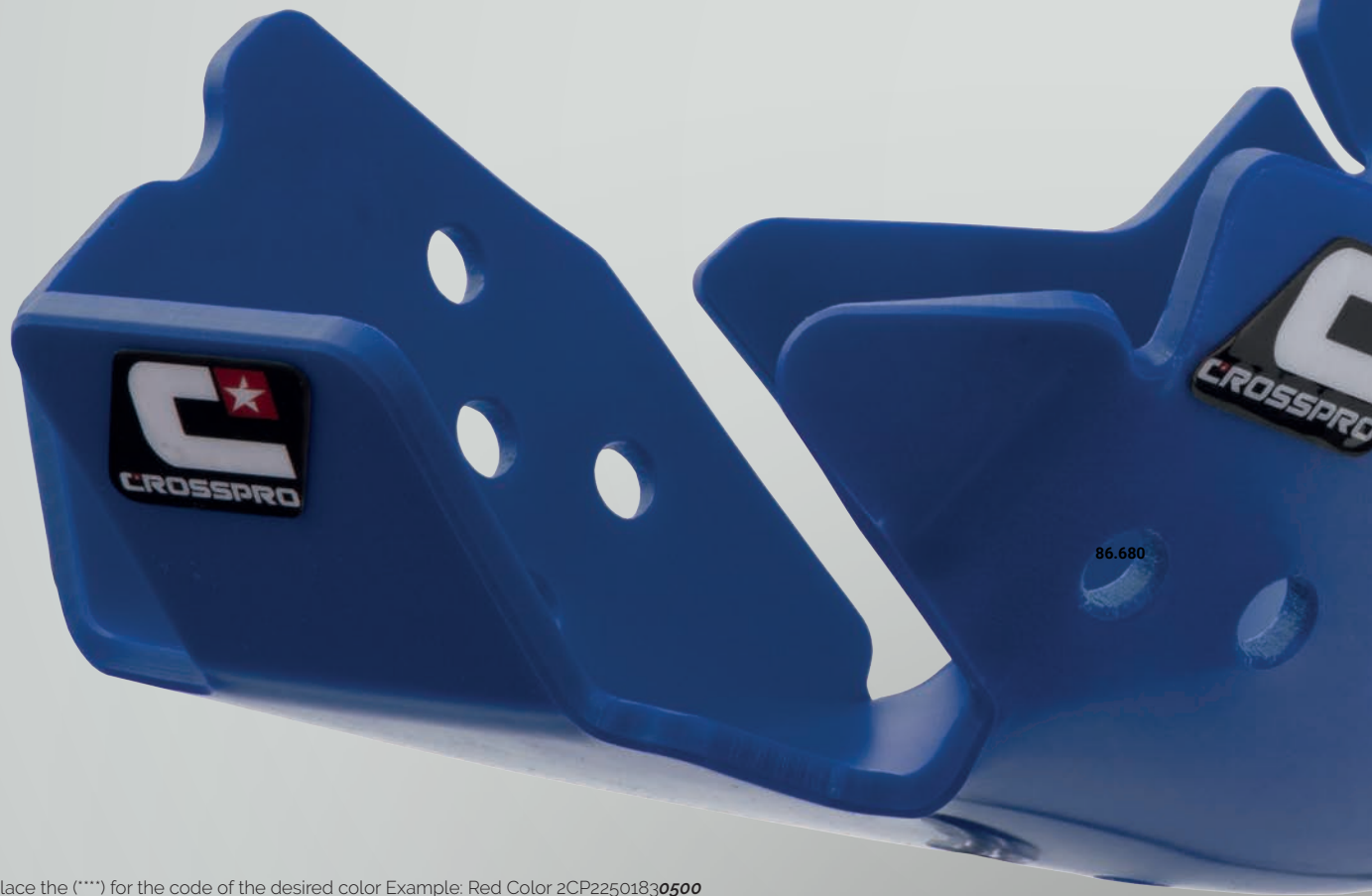

- » Replace the (\*\*\*\*) for the code of the desired color Example: Red Color 2CP2250183**0500**
- » Substituir os (\*\*\*\*) pelo código de cor pretendida Exemplo: para a cor vermelha 2CP2250183**0500**

|                |              |                 |                 |                   |                   |
|----------------|--------------|-----------------|-----------------|-------------------|-------------------|
| »0300          | »0400        | »0500           | »0600           | »0700             | »0800             |
| Black<br>Preto | Blue<br>Azul | Red<br>Vermelho | White<br>Branco | Yellow<br>Amarelo | Orange<br>Laranja |





# 11

## HARD LINK<sup>DTC</sup>

### DTC HARD engine guard with link reinforcement protection

The maximum demand of our customers, the new trends and the philosophy of continuous improvement, naturally led to the upgrade of the developed DTC protections.

The new protection, in addition to strengthening the link area, has a reinforcement in the areas of the frame, increasing the protection of your bike.

- Extra protection for the link, now with 12mm that will reinforce the protection in this sensible part of your bike
- Easy to apply, you can remove or putt adjusting the skidplate to the "hardness" of each race
- Protection adjusted to races with more obstacles
- Removable and easily replaceable

### Proteções de motor DTC com proteção de link reforçado

A máxima exigência dos nossos clientes, as novas tendências e a filosofia de melhoria contínua, naturalmente levaram ao upgrade das proteções de DTC desenvolvidas.

A nova protecção, além do reforço da zona do link, tem um reforço nas zonas do quadro, aumentando a protecção da sua moto.

- Extra protecção na zona de link, agora com 12mm que reforçará a protecção desta zona sensível da sua moto
- De fácil aplicação, pode remover ou colocar ajustando a protecção à exigência de cada corrida
- Protecção ajustada e adequada a corridas com mais obstáculos
- Removível e de fácil substituição

| BETA      | YEAR      | CODE                    |
|-----------|-----------|-------------------------|
| RR 2T 250 | 2020      | 2CP225 <b>0204</b> **** |
| RR 2T 300 | 2020      | 2CP225 <b>0204</b> **** |
| RR 4T 350 | 2020      | 2CP225 <b>0205</b> **** |
| RR 4T 390 | 2020      | 2CP225 <b>0205</b> **** |
| RR 4T 430 | 2020      | 2CP225 <b>0205</b> **** |
| RR 4T 480 | 2020      | 2CP225 <b>0205</b> **** |
| HUSQVARNA | YEAR      | CODE                    |
| FC 250    | 2016-2018 | 2CP225 <b>0151</b> **** |
| FE 250    | 2017-2018 | 2CP225 <b>0151</b> **** |
| FE 250    | 2019-2020 | 2CP225 <b>0201</b> **** |
| TE 250    | 2017-2019 | 2CP225 <b>0167</b> **** |
| TE 250    | 2020      | 2CP225 <b>0202</b> **** |
| TE 300    | 2017-2019 | 2CP225 <b>0167</b> **** |
| TE 300    | 2020      | 2CP225 <b>0202</b> **** |
| FC 350    | 2016-2018 | 2CP225 <b>0151</b> **** |
| FE 350    | 2017-2018 | 2CP225 <b>0151</b> **** |
| FC 450    | 2016-2018 | 2CP225 <b>0153</b> **** |
| FE 450    | 2017-2018 | 2CP225 <b>0153</b> **** |
| FE 350    | 2019-2020 | 2CP225 <b>0201</b> **** |
| KTM       | YEAR      | CODE                    |
| 250 SX    | 2017-2018 | 2CP225 <b>0167</b> **** |
| 250 XC    | 2017-2018 | 2CP225 <b>0167</b> **** |
| 300 XC    | 2017-2018 | 2CP225 <b>0167</b> **** |
| 250 SX    | 2020      | 2CP225 <b>0202</b> **** |
| 250 XC    | 2020      | 2CP225 <b>0202</b> **** |
| 250 SX-F  | 2016-2018 | 2CP225 <b>0151</b> **** |
| 250 XC-F  | 2016-2018 | 2CP225 <b>0151</b> **** |
| 350 SX-F  | 2016-2018 | 2CP225 <b>0151</b> **** |
| 350 XC-F  | 2016-2018 | 2CP225 <b>0151</b> **** |
| 450 SX-F  | 2016-2018 | 2CP225 <b>0153</b> **** |
| 450 XC-F  | 2016-2018 | 2CP225 <b>0153</b> **** |

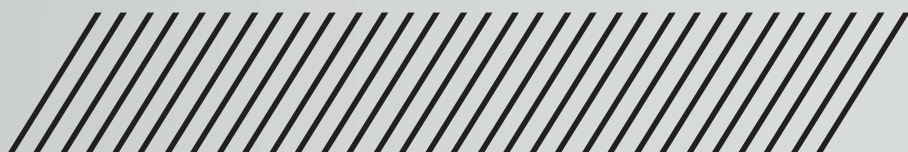



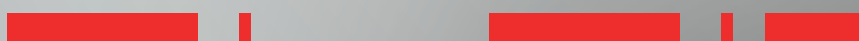

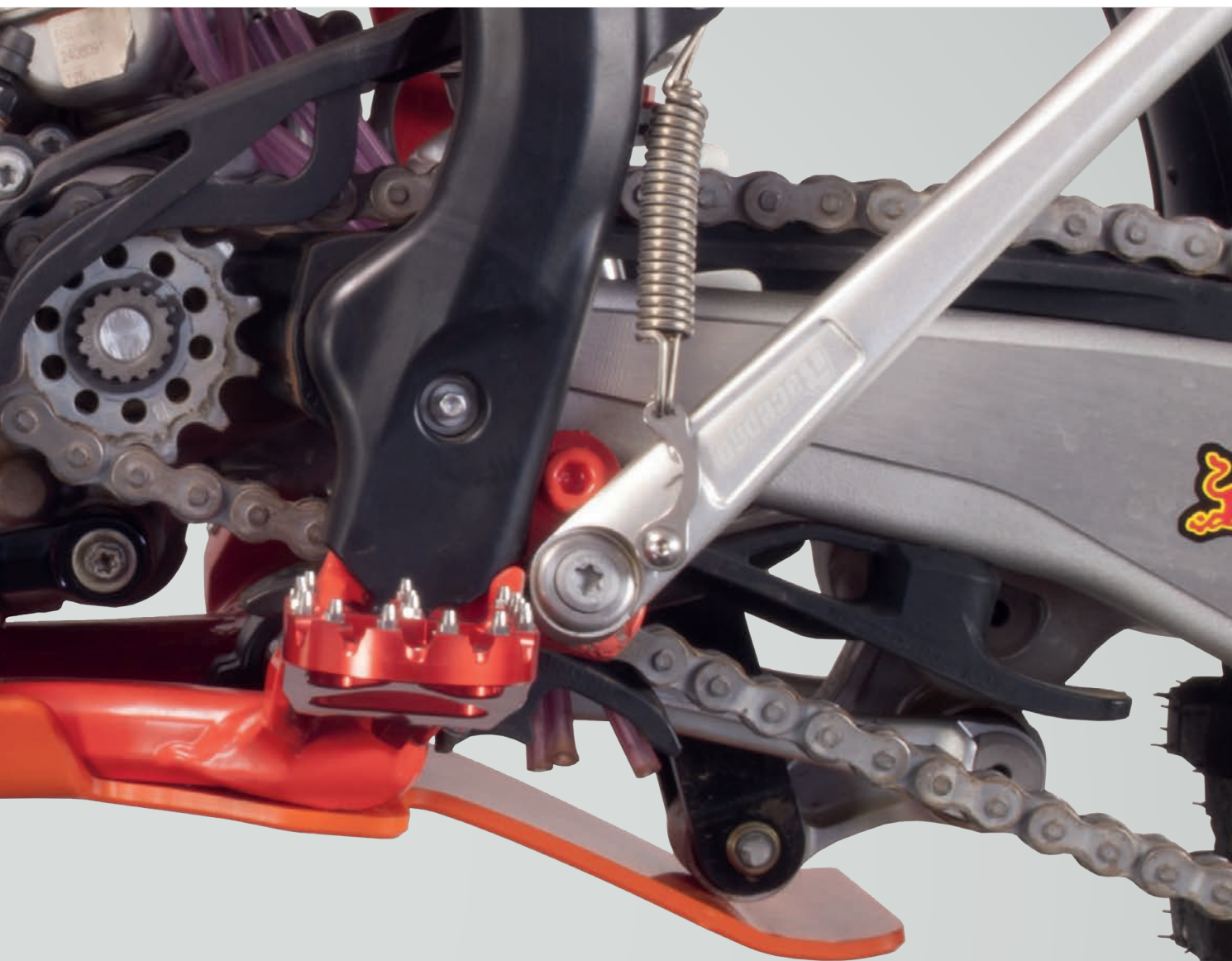

# LINK **DTC**





- » Replace the (\*\*\*\*) for the code of the desired color Example: Red Color 2CP19301830500
- » Substituir os (\*\*\*\*) pelo código de cor pretendida: Exemplo: para a cor vermelha 2CP19301830500

|  |   |   |   |   |   |
|--|---|---|---|---|---|
|  »0300 |  »0400 |  »0500 |  »0600 |  »0700 |  »0800 |
| Black<br>Preto   | Blue<br>Azul  | Red<br>Vermelho   | White<br>Branco   | Yellow<br>Amarelo   | Orange<br>Laranja   |

**13**  
**LINKDTC**



#### DTC enduro engine guard with link protection

//Noting the increasing necessity to protect more the bikes, CrossPro introduce in the range the DTC Engine Protection, that now also protect the Suspension Link.

//One complete piece for protect your bike for frame, carter and suspension link protection

//Extra protection for extreme conditions

//Made by 6mm best quality DTC, with no welding, these engine guards are 40% lighter than aluminum, dont break and dont cause vibrations, and is much more resistant to impact.

//Available in different colors

#### Proteções de motor DTC com proteção de link

//Detetando a necessidade crescente de aumentar a proteção das motos, a CrossPro introduz na sua gama uma Proteção de Motor em DTC, que protege agora também o Link de Suspensão.

// Uma peça única e completa para proteção da sua moto, carter, quadro e Link de suspensão.

// Proteção extra para condições extremas

// Testado em competição

// Produzido em DTC da melhor qualidade com 6mm, sem solda, estas proteções de motor são 40% mais leves que o alumínio, não quebram e não causam vibrações, e muito mais resistente ao impacto.

// Disponível em diferentes cores

LINKDTC



Brad Freeman  
world Enduro Champion



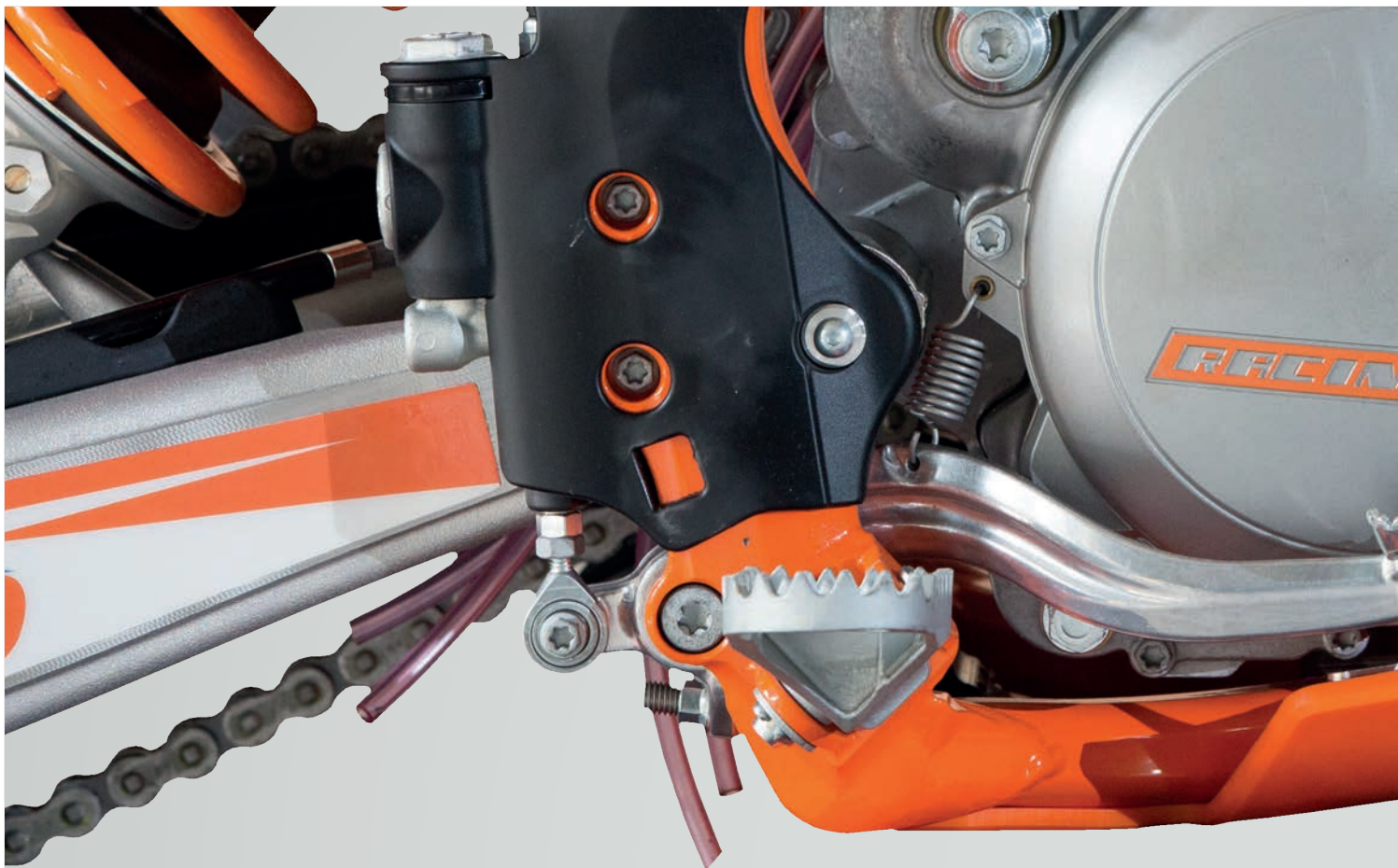

# ENDURO

DTC













**17**  
**ENDURO**  
**DTC**

- » Replace the (\*\*\*\*) for the code of the desired color Example: Red Color 2CP0850183**0500**
- » Substituir os (\*\*\*\*) pelo código de cor pretendida: Exemplo: para a cor vermelha 2CP0850183**0500**

|  |   |   |   |   |   |
|--|---|---|---|---|---|
|  »0300 |  »0400 |  »0500 |  »0600 |  »0700 |  »0800 |
| Black<br>Preto   | Blue<br>Azul  | Red<br>Vermelho   | White<br>Branco   | Yellow<br>Amarelo   | Orange<br>Laranja   |



#### DTC enduro engine guard

//Tested in competition, these engine guards offer you the best protection for the engine and for the frame of your bike.  
 //Made by 6mm best quality DTC, with no welding, these engine guards are 40% lighter than aluminum, don't break and don't cause vibrations, and is much more resistant to impact.  
 //Available in different colors

#### Protecções de motor DTC enduro

//Testado em competição, estas protecções de motor oferecem a melhor protecção para o motor e para o quadro de sua moto.  
 //Produzido em DTC da melhor qualidade com 6mm, sem solda, estas protecções de motor são 40% mais leves que o alumínio, não quebram e não causam vibrações, e são muito mais resistente ao impacto.  
 //Disponíveis em diferentes cores



Eero Remes

| AJP     | YEAR      | CODE             |
|---------|-----------|------------------|
| PR3 125 | 2010-2015 | 2CP085 0076 **** |
| PR4 125 | 2010-2015 | 2CP085 0076 **** |
| PR3 200 | 2010-2015 | 2CP085 0076 **** |
| PR4 200 | 2010-2015 | 2CP085 0076 **** |
| PR3 240 | 2013-2015 | 2CP085 0076 **** |
| PR4 240 | 2013-2015 | 2CP085 0076 **** |
| PR5 250 | 2013-2015 | 2CP085 0118 **** |

| BETA          | YEAR      | CODE             |
|---------------|-----------|------------------|
| RR 2T 125     | 2018      | 2CP085 0183 **** |
| RR 4T 125 LC  | 2010-2015 | 2CP085 0127 **** |
| RR 2T 250     | 2013-2017 | 2CP085 0116 **** |
| RR 2T 250     | 2018-2019 | 2CP085 0178 **** |
| RR 2T 250     | 2020      | 2CP085 0204 **** |
| RR 2T 300     | 2013-2017 | 2CP085 0116 **** |
| RR 2T 300     | 2018-2019 | 2CP085 0178 **** |
| RR 2T 300     | 2020      | 2CP085 0204 **** |
| X-Trainer 300 | 2015      | 2CP085 0150 **** |
| RR 4T 350     | 2011-2017 | 2CP085 0121 **** |
| RR 4T 350     | 2011-2017 | 2CP085 121A **** |
| RR 4T 350     | 2018-2019 | 2CP085 0184 **** |
| RR 4T 350     | 2020      | 2CP085 0205 **** |
| RR 4T 390     | 2015-2017 | 2CP085 0121 **** |
| RR 4T 390     | 2015-2017 | 2CP085 121A **** |
| RR 4T 390     | 2018-2019 | 2CP085 0184 **** |
| RR 4T 390     | 2020      | 2CP085 0205 **** |
| RR 4T 400     | 2010-2014 | 2CP085 0121 **** |
| RR 4T 400     | 2010-2014 | 2CP085 121A **** |
| RR 4T 430     | 2015-2017 | 2CP085 0121 **** |
| RR 4T 430     | 2015-2017 | 2CP085 121A **** |
| RR 4T 430     | 2018-2019 | 2CP085 0184 **** |
| RR 4T 430     | 2020      | 2CP085 0205 **** |
| RR 4T 450     | 2010-2014 | 2CP085 0121 **** |
| RR 4T 450     | 2010-2014 | 2CP085 121A **** |
| RR 4T 480     | 2015-2017 | 2CP085 0121 **** |
| RR 4T 480     | 2015-2017 | 2CP085 121A **** |
| RR 4T 480     | 2018-2019 | 2CP085 0184 **** |
| RR 4T 480     | 2020      | 2CP085 0205 **** |
| RR 4T 498     | 2012-2014 | 2CP085 0121 **** |
| RR 4T 498     | 2012-2014 | 2CP085 121A **** |
| RR 4T 520     | 2010-2011 | 2CP085 0121 **** |
| RR 4T 520     | 2010-2011 | 2CP085 121A **** |

| GAS GAS | YEAR      | CODE             |
|---------|-----------|------------------|
| EC 125  | 2012-2013 | 2CP085 0123 **** |
| EC 200  | 2010-2011 | 2CP085 0008 **** |
| EC 200  | 2012-2013 | 2CP085 0088 **** |
| EC 200  | 2014-2017 | 2CP085 0129 **** |
| EC 250  | 2010-2011 | 2CP085 0008 **** |
| EC 250  | 2012-2013 | 2CP085 0088 **** |
| EC 250  | 2014-2017 | 2CP085 0129 **** |
| EC 250  | 2018      | 2CP085 0179 **** |
| XC 250  | 2018      | 2CP085 0179 **** |

| GAS GAS (contin.) | YEAR      | CODE             |
|-------------------|-----------|------------------|
| EC 300            | 2010-2011 | 2CP085 0008 **** |
| EC 300            | 2012-2013 | 2CP085 0088 **** |
| EC 300            | 2014-2017 | 2CP085 0129 **** |
| EC 300            | 2018      | 2CP085 0179 **** |
| XC 300            | 2018      | 2CP085 0179 **** |

| HONDA     | YEAR      | CODE             |
|-----------|-----------|------------------|
| CRF 150R  | 2007-2018 | 2CP085 0113 **** |
| CRF 250R  | 2004-2009 | 2CP085 005A **** |
| CRF 250R  | 2011-2013 | 2CP085 0075 **** |
| CRF 250R  | 2014-2017 | 2CP085 0126 **** |
| CRF 250R  | 2018-2019 | 2CP085 0185 **** |
| CRF 300RX | 2019      | 2CP085 0185 **** |
| CRF 250X  | 2004-2017 | 2CP085 0004 **** |
| CRF 450L  | 2019      | 2CP085 0195 **** |
| CRF 450R  | 2009-2016 | 2CP085 0114 **** |
| CRF 450R  | 2017-2019 | 2CP085 0176 **** |
| CRF 450RX | 2017-2019 | 2CP085 0176 **** |
| CRF 450X  | 2005-2018 | 2CP085 0003 **** |

| HUSABERG | YEAR      | CODE             |
|----------|-----------|------------------|
| TE 125   | 2012-2013 | 2CP085 0063 **** |
| TE 125   | 2012-2013 | 2CP085 063B **** |
| KX 250 F | 2013      | 2CP085 0090 **** |
| TE 250   | 2012      | 2CP085 0069 **** |
| TE 250   | 2013      | 2CP085 0097 **** |
| TE 300   | 2012      | 2CP085 0069 **** |
| TE 300   | 2013      | 2CP085 0097 **** |
| FE 350   | 2013      | 2CP085 0084 **** |
| FE 350   | 2013      | 2CP085 084A **** |
| FE 350   | 2013      | 2CP085 111B **** |
| FE 450   | 2013      | 2CP085 0137 **** |
| FE 501   | 2013      | 2CP085 0137 **** |

| HUSQVARNA | YEAR      | CODE             |
|-----------|-----------|------------------|
| TC 85     | 2016      | 2CP085 0154 **** |
| TE 125    | 2014-2016 | 2CP085 0132 **** |
| TX 125    | 2019      | 2CP085 0187 **** |
| TE 150    | 2019      | 2CP085 0187 **** |
| FC 250    | 2014-2015 | 2CP085 111B **** |
| FC 250    | 2016-2018 | 2CP085 151A **** |
| FC 250    | 2019      | 2CP085 0188 **** |
| FE 250    | 2014      | 2CP085 0131 **** |
| FE 250    | 2014-2016 | 2CP085 111B **** |
| FE 250    | 2017-2018 | 2CP085 151A **** |
| FE 250    | 2019-2020 | 2CP085 0201 **** |
| TC 250    | 2011-2013 | 2CP085 0078 **** |
| TC 250    | 2019      | 2CP085 0190 **** |
| TE 250    | 2011-2013 | 2CP085 0078 **** |
| TE 250    | 2014-2015 | 2CP085 100A **** |
| TE 250    | 2016      | 2CP085 0156 **** |
| TE 250    | 2017-2019 | 2CP085 167B **** |
| TE 250    | 2020      | 2CP085 0202 **** |

| HUSQVARNA (contin.) | YEAR      | CODE             |
|---------------------|-----------|------------------|
| TE 300              | 2014-2015 | 2CP085 100A **** |
| TE 300              | 2016      | 2CP085 0156 **** |
| TE 300              | 2017-2019 | 2CP085 167B **** |
| TE 300              | 2020      | 2CP085 0202 **** |
| TE 310              | 2011-2013 | 2CP085 0078 **** |
| FC 350              | 2014-2015 | 2CP085 111B **** |
| FC 350              | 2016-2018 | 2CP085 151A **** |
| FC 350              | 2019      | 2CP085 0188 **** |
| FE 350              | 2014-2016 | 2CP085 111B **** |
| FE 350              | 2017-2018 | 2CP085 151A **** |
| FE 350              | 2019-2020 | 2CP085 0201 **** |
| FE 350S             | 2016      | 2CP085 111B **** |
| FC 450              | 2015      | 2CP085 0144 **** |
| FC 450              | 2016-2018 | 2CP085 153A **** |
| FC 450              | 2019      | 2CP085 0189 **** |
| FE 450              | 2015-2016 | 2CP085 0144 **** |
| FE 450              | 2017-2018 | 2CP085 153A **** |
| FE 501              | 2015-2016 | 2CP085 0144 **** |
| FE 501S             | 2016      | 2CP085 0144 **** |

| KAWASAKI | YEAR      | CODE             |
|----------|-----------|------------------|
| KX 85    | 2004-2014 | 2CP085 0112 **** |
| KX 250 F | 2008      | 2CP085 0019 **** |
| KX 250 F | 2010-2016 | 2CP085 065A **** |
| KX 250 F | 2017-2018 | 2CP085 0173 **** |
| KX 450 F | 2012-2015 | 2CP085 0089 **** |
| KX 450 F | 2016      | 2CP085 0152 **** |
| KX 450 F | 2017-2018 | 2CP085 0174 **** |
| KX 450 F | 2019      | 2CP085 0192 **** |

| KTM      | YEAR      | CODE             |
|----------|-----------|------------------|
| 65 SX    | 2014      | 2CP085 0130 **** |
| 65 SX    | 2014      | 2CP085 130A **** |
| 85 SX    | 2003-2015 | 2CP085 0104 **** |
| 85 SX    | 2016      | 2CP085 0154 **** |
| 125 EXC  | 2008-2015 | 2CP085 0063 **** |
| 125 EXC  | 2008-2016 | 2CP085 063B **** |
| 125 EXC  | 2017      | 2CP085 0187 **** |
| 125 SX   | 2007-2011 | 2CP085 0063 **** |
| 125 SX   | 2007-2011 | 2CP085 063B **** |
| 125 SX   | 2012-2015 | 2CP085 0107 **** |
| 125 SX   | 2012-2015 | 2CP085 107A **** |
| 125 SX   | 2016-2018 | 2CP085 0164 **** |
| 125 SX   | 2019      | 2CP085 0187 **** |
| 125 XC-W | 2017-2018 | 2CP085 0187 **** |
| 150 SX   | 2009-2011 | 2CP085 0063 **** |
| 150 SX   | 2009-2011 | 2CP085 063B **** |
| 150 SX   | 2012-2015 | 2CP085 0107 **** |
| 150 SX   | 2012-2015 | 2CP085 107A **** |
| 150 SX   | 2016-2018 | 2CP085 0164 **** |
| 150 XC   | 2010-2011 | 2CP085 0063 **** |
| 150 XC   | 2010-2011 | 2CP085 063B **** |
| 150 XC   | 2012-2014 | 2CP085 0107 **** |
| 150 XC   | 2012-2014 | 2CP085 107A **** |

- » Replace the (\*\*\*\*) for the code of the desired color Example: Red Color 2CP0850183**0500**
- » Substituir os (\*\*\*\*) pelo código de cor pretendida.Exemplo: para a cor vermelha 2CP0850183**0500**

- »0300 Black Preto
- »0400 Blue Azul
- »0500 Red Vermelho
- »0600 White Branco
- »0700 Yellow Amarelo
- »0800 Orange Laranja

**ENDURO**  
DTC



**19**

| KTU (contin.)  | YEAR      | CODE             |
|----------------|-----------|------------------|
| 150 XC-W       | 2017-2018 | 2CP085 0187 **** |
| 200 EXC        | 2008-2015 | 2CP085 0063 **** |
| 200 EXC        | 2008-2016 | 2CP085 063B **** |
| 200 XC         | 2007      | 2CP085 0063 **** |
| 200 XC         | 2007      | 2CP085 063B **** |
| 200 XC-W       | 2008-2009 | 2CP085 0063 **** |
| 200 XC-W       | 2008-2009 | 2CP085 063B **** |
| 200 XC-W       | 2011-2013 | 2CP085 0063 **** |
| 200 XC-W       | 2011-2013 | 2CP085 063B **** |
| 200 XC-W       | 2016      | 2CP085 063B **** |
| 250 EXC        | 2009-2011 | 2CP085 0069 **** |
| 250 EXC        | 2012-2013 | 2CP085 0097 **** |
| 250 EXC        | 2014-2016 | 2CP085 100A **** |
| 250 EXC        | 2017-2019 | 2CP085 167B **** |
| 250 EXC        | 2020      | 2CP085 0202 **** |
| 250 EXC-F      | 2008-2011 | 2CP085 0039 **** |
| 250 EXC-F      | 2012-2016 | 2CP085 111B **** |
| 250 EXC-F      | 2014      | 2CP085 0122 **** |
| 250 EXC-F      | 2017-2020 | 2CP085 0201 **** |
| 250 SX         | 2007-2011 | 2CP085 0069 **** |
| 250 SX         | 2012-2015 | 2CP085 100A **** |
| 250 SX         | 2019      | 2CP085 0190 **** |
| 250 SX         | 2020      | 2CP085 0202 **** |
| 250 SX-F       | 2007-2010 | 2CP085 0039 **** |
| 250 SX-F       | 2011-2012 | 2CP085 0090 **** |
| 250 SX-F       | 2013-2014 | 2CP085 0119 **** |
| 250 SX-F       | 2013-2015 | 2CP085 111B **** |
| 250 SX-F       | 2016-2018 | 2CP085 151A **** |
| 250 SX-F       | 2019      | 2CP085 0188 **** |
| 250 XC         | 2006-2007 | 2CP085 0069 **** |
| 250 XC         | 2010-2011 | 2CP085 0069 **** |
| 250 XC         | 2012-2015 | 2CP085 100A **** |
| 250 XC         | 2019      | 2CP085 0190 **** |
| 250 XC         | 2020      | 2CP085 0202 **** |
| 250 XC-F       | 2007      | 2CP085 0039 **** |
| 250 XC-F       | 2011-2015 | 2CP085 111B **** |
| 250 XC-F       | 2016-2018 | 2CP085 151A **** |
| 250 XC-F       | 2019      | 2CP085 0188 **** |
| 250 XC-W       | 2008-2011 | 2CP085 0069 **** |
| 250 XC-W       | 2012-2013 | 2CP085 0097 **** |
| 250 XC-W       | 2016      | 2CP085 100A **** |
| 250 XC-W       | 2017-2019 | 2CP085 167B **** |
| 250 XCF-W      | 2008-2010 | 2CP085 0039 **** |
| 250 XCF-W      | 2012-2014 | 2CP085 111B **** |
| 250 XCF-W      | 2016      | 2CP085 111B **** |
| FREERIDE 250 R | 2014-2015 | 2CP085 0146 **** |
| 300 EXC        | 2009-2011 | 2CP085 0069 **** |
| 300 EXC        | 2012-2013 | 2CP085 0097 **** |
| 300 EXC        | 2014-2016 | 2CP085 100A **** |
| 300 EXC        | 2017-2019 | 2CP085 167B **** |
| 300 EXC        | 2020      | 2CP085 0202 **** |
| 300 XC         | 2007      | 2CP085 0069 **** |
| 300 XC         | 2010-2011 | 2CP085 0069 **** |
| 300 XC         | 2012-2015 | 2CP085 100A **** |
| 300 XC         | 2019      | 2CP085 0190 **** |

| KTU (contin.) | YEAR      | CODE             |
|---------------|-----------|------------------|
| 300 XC-W      | 2008-2011 | 2CP085 0069 **** |
| 300 XC-W      | 2012-2013 | 2CP085 0097 **** |
| 300 XC-W      | 2016      | 2CP085 100A **** |
| 300 XC-W      | 2017-2019 | 2CP085 167B **** |
| 350 EXC-F     | 2012-2014 | 2CP085 0084 **** |
| 350 EXC-F     | 2012-2015 | 2CP085 084A **** |
| 350 EXC-F     | 2012-2016 | 2CP085 111B **** |
| 350 EXC-F     | 2017-2020 | 2CP085 0201 **** |
| 350 SX-F      | 2011-2015 | 2CP085 111B **** |
| 350 SX-F      | 2016-2018 | 2CP085 151A **** |
| 350 SX-F      | 2019      | 2CP085 0188 **** |
| 350 XC-F      | 2011-2015 | 2CP085 111B **** |
| 350 XC-F      | 2016-2018 | 2CP085 151A **** |
| 350 XC-F      | 2019      | 2CP085 0188 **** |
| 350 XCF-W     | 2012-2016 | 2CP085 111B **** |
| 450 EXC-F     | 2012-2013 | 2CP085 0085 **** |
| 450 EXC-F     | 2012-2016 | 2CP085 0137 **** |
| 450 EXC-F     | 2017-2019 | 2CP085 0168 **** |
| 450 SX-F      | 2013-2014 | 2CP085 0102 **** |
| 450 SX-F      | 2013-2014 | 2CP085 102A **** |
| 450 SX-F      | 2015      | 2CP085 0144 **** |
| 450 SX-F      | 2016-2018 | 2CP085 153A **** |
| 450 SX-F      | 2019      | 2CP085 0189 **** |
| 450 XC-F      | 2015      | 2CP085 0144 **** |
| 450 XC-F      | 2016-2018 | 2CP085 153A **** |
| 450 XC-F      | 2019      | 2CP085 0189 **** |
| 450 XC-W      | 2012-2013 | 2CP085 0137 **** |
| 450 XC-W      | 2015-2016 | 2CP085 0137 **** |
| 500 EXC-F     | 2012-2013 | 2CP085 0085 **** |
| 500 EXC-F     | 2012-2016 | 2CP085 0137 **** |
| 500 EXC-F     | 2017-2019 | 2CP085 0168 **** |
| 500 XC-W      | 2012-2016 | 2CP085 0137 **** |

| SHERCO   | YEAR      | CODE             |
|----------|-----------|------------------|
| SE 50R   | 2014-2017 | 2CP085 0177 **** |
| SM 50R   | 2014-2017 | 2CP085 0177 **** |
| SE 125R  | 2018      | 2CP085 0182 **** |
| SE 250R  | 2014-2016 | 2CP085 0099 **** |
| SE 250R  | 2017-2018 | 2CP085 0175 **** |
| SE 250R  | 2019      | 2CP085 0197 **** |
| SEF 250R | 2012-2014 | 2CP085 0092 **** |
| SEF 250R | 2015-2016 | 2CP085 0134 **** |
| SEF 250R | 2015-2018 | 2CP085 134A **** |
| SEF 250R | 2019      | 2CP085 0198 **** |
| SE 300R  | 2014-2016 | 2CP085 0099 **** |
| SE 300R  | 2017-2018 | 2CP085 0175 **** |
| SE 300R  | 2019      | 2CP085 0197 **** |
| SEF 300R | 2012-2014 | 2CP085 0092 **** |
| SEF 300R | 2015-2016 | 2CP085 0134 **** |
| SEF 300R | 2015-2018 | 2CP085 134A **** |
| SEF 300R | 2019      | 2CP085 0198 **** |

| SUZUKI     | YEAR      | CODE             |
|------------|-----------|------------------|
| RM 85      | 2002-2015 | 2CP085 0106 **** |
| RM-Z 250   | 2010-2014 | 2CP085 059A **** |
| RM-Z 250   | 2015-2016 | 2CP085 0138 **** |
| RM-Z 250   | 2015-2018 | 2CP085 138A **** |
| DR-Z 400   | 2000-2004 | 2CP085 0068 **** |
| DR-Z 400E  | 2000-2007 | 2CP085 0068 **** |
| DR-Z 400S  | 2000-2015 | 2CP085 0068 **** |
| DR-Z 400SM | 2005-2009 | 2CP085 0068 **** |
| DR-Z 400SM | 2013-2015 | 2CP085 0068 **** |
| RM-Z 450   | 2010-2017 | 2CP085 058C **** |
| RM-Z 450   | 2018      | 2CP085 0186 **** |

| TM        | YEAR      | CODE             |
|-----------|-----------|------------------|
| EN/MX 125 | 2016-2019 | 2CP085 0191 **** |
| EN/MX 144 | 2016-2019 | 2CP085 0191 **** |
| EN/MX 250 | 2011-2014 | 2CP085 0125 **** |
| EN/MX 250 | 2015-2018 | 2CP085 0155 **** |
| EN/MX 250 | 2019      | 2CP085 0194 **** |
| EN 250F   | 2016      | 2CP085 0170 **** |
| EN/MX 300 | 2011-2014 | 2CP085 0125 **** |
| EN/MX 300 | 2015-2018 | 2CP085 0155 **** |
| EN/MX 300 | 2019      | 2CP085 0194 **** |

| YAMAHA   | YEAR      | CODE             |
|----------|-----------|------------------|
| YZ 65    | 2018-2019 | 2CP085 0200 **** |
| YZ 85    | 2004-2018 | 2CP085 0110 **** |
| YZ 125   | 2006-2018 | 2CP085 0020 **** |
| WR 250 F | 2007-2014 | 2CP085 0108 **** |
| WR 250 F | 2015      | 2CP085 0145 **** |
| WR 250 F | 2015-2019 | 2CP085 145A **** |
| WR 250 F | 2015-2019 | 2CP085 145B **** |
| YZ 250   | 2005-2019 | 2CP085 0017 **** |
| YZ 250   | 2005-2019 | 2CP085 017A **** |
| YZ 250 F | 2006-2009 | 2CP085 0016 **** |
| YZ 250 F | 2010-2013 | 2CP085 095B **** |
| YZ 250 F | 2014-2018 | 2CP085 0128 **** |
| YZ 250 F | 2019      | 2CP085 0193 **** |
| YZ 250 X | 2016      | 2CP085 0165 **** |
| WR 450 F | 2012-2015 | 2CP085 0098 **** |
| WR 450 F | 2016-2018 | 2CP085 0163 **** |
| WR 450 F | 2016-2018 | 2CP085 163A **** |
| WR 450 F | 2019      | 2CP085 0196 **** |
| YZ 450 F | 2010-2013 | 2CP085 094A **** |
| YZ 450 F | 2010-2013 | 2CP085 094B **** |
| YZ 450 F | 2014-2017 | 2CP085 0124 **** |
| YZ 450 F | 2014-2017 | 2CP085 124A **** |
| YZ 450 F | 2018      | 2CP085 0180 **** |
| YZ 450 F | 2018      | 2CP085 180A **** |
| YZ 450 F | 2019      | 2CP085 0196 **** |

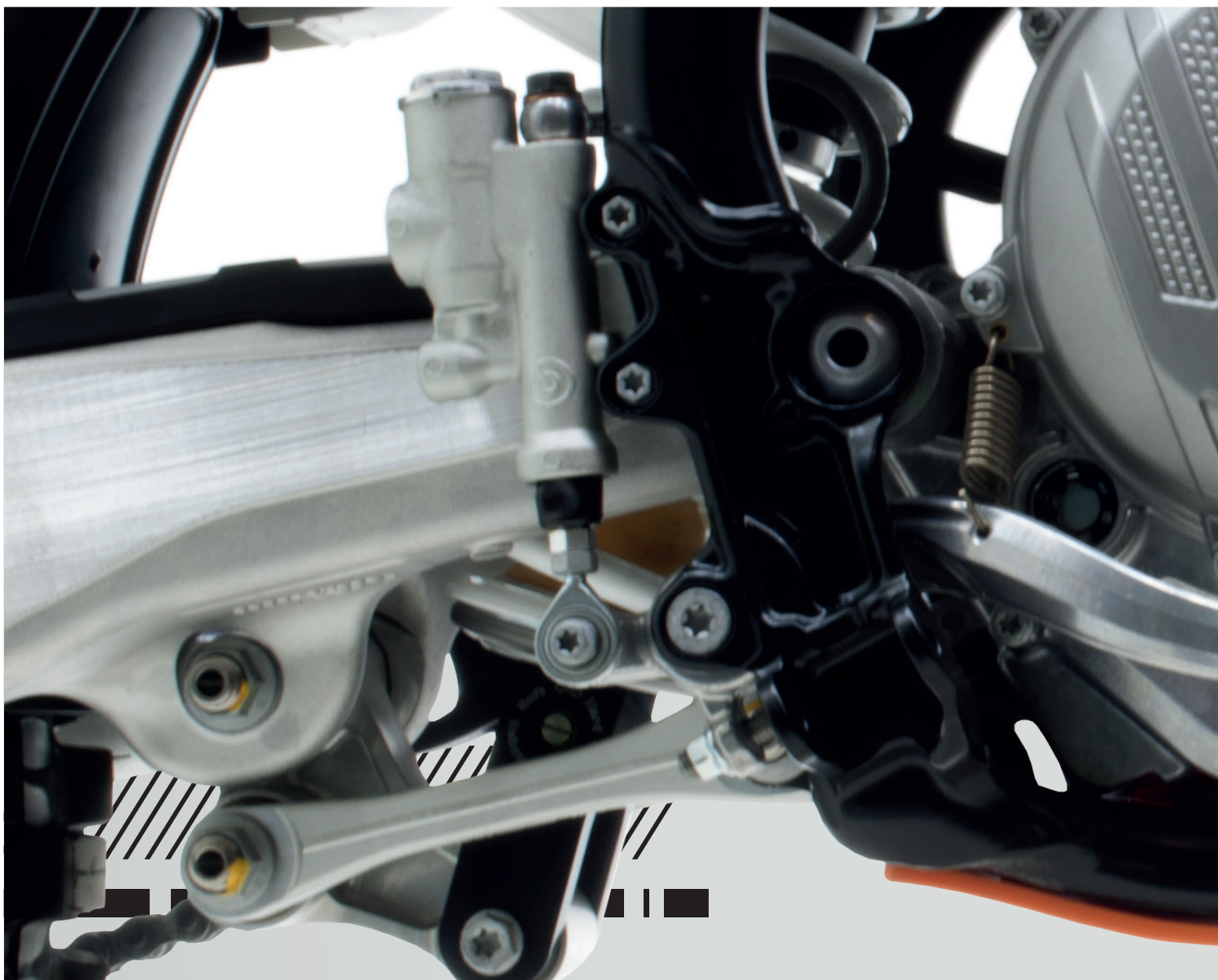

**MX**DTC

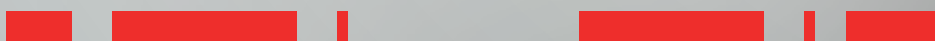









# 21

## MXDTC

- » Replace the (\*\*\*\*) for the code of the desired color Example: Red Color 2CP0790183**0500**
- » Substituir os (\*\*\*\*) pelo código de cor pretendida:Exemplo: para a cor vermelha 2CP0790183**0500**

|  |   |   |   |   |   |
|--|---|---|---|---|---|
|  »0300 |  »0400 |  »0500 |  »0600 |  »0700 |  »0800 |
| Black<br>Preto   | Blue<br>Azul  | Red<br>Vermelho   | White<br>Branco   | Yellow<br>Amarelo   | Orange<br>Laranja   |



### DTC motocross Engine Guard

//Tested in competition, these engine guards offer you the best protection for the engine and for the frame of your bike.  
//Made by 6mm best quality DTC, with no welding, these engine guards are 40% lighter than aluminum, don't break and don't cause vibrations, and is much more resistant to impact.  
//Available in different colors

### Protecções de motor DTC motocross

//Testado em competição, estas protecções de motor oferecem a melhor protecção para o motor e para o quadro de sua moto.  
//Produzido em DTC da melhor qualidade com 6mm, sem solda, estas protecções de motor são 40% mais leves que o alumínio, não quebram e não causam vibrações, e são muito mais resistente ao impacto.  
//Disponíveis em diferentes cores você pode escolher agora as melhores protecções de sempre para a sua moto.



# MXDTC

## AJP

| YEAR | CODE |
|------|------|
|------|------|

|         |                            |
|---------|----------------------------|
| PR5 250 | 2013-2015 2CP079 0118 **** |
|---------|----------------------------|

## BETA

| YEAR | CODE |
|------|------|
|------|------|

|               |                            |
|---------------|----------------------------|
| RR 4T 125 LC  | 2010-2015 2CP079 0127 **** |
| RR 2T 250     | 2013-2017 2CP079 0116 **** |
| RR 2T 300     | 2013-2017 2CP079 0116 **** |
| X-Trainer 300 | 2015 2CP079 0150 ****      |
| RR 4T 350     | 2011-2017 2CP079 0121 **** |
| RR 4T 350     | 2011-2017 2CP079 121A **** |
| RR 4T 350     | 2018-2019 2CP079 0184 **** |
| RR 4T 390     | 2015-2017 2CP079 0121 **** |
| RR 4T 390     | 2015-2017 2CP079 121A **** |
| RR 4T 390     | 2018-2019 2CP079 0184 **** |
| RR 4T 400     | 2010-2014 2CP079 0121 **** |
| RR 4T 400     | 2010-2014 2CP079 121A **** |
| RR 4T 430     | 2015-2017 2CP079 0121 **** |
| RR 4T 430     | 2015-2017 2CP079 121A **** |
| RR 4T 430     | 2018-2019 2CP079 0184 **** |
| RR 4T 450     | 2010-2014 2CP079 0121 **** |
| RR 4T 450     | 2010-2014 2CP079 121A **** |
| RR 4T 480     | 2015-2017 2CP079 0121 **** |
| RR 4T 480     | 2015-2017 2CP079 121A **** |
| RR 4T 480     | 2018-2019 2CP079 0184 **** |
| RR 4T 498     | 2012-2014 2CP079 0121 **** |
| RR 4T 498     | 2012-2014 2CP079 121A **** |
| RR 4T 520     | 2010-2011 2CP079 0121 **** |
| RR 4T 520     | 2010-2011 2CP079 121A **** |

## GAS GAS

| YEAR | CODE |
|------|------|
|------|------|

|        |                            |
|--------|----------------------------|
| EC 125 | 2012-2013 2CP079 0123 **** |
| EC 200 | 2010-2011 2CP079 0008 **** |
| EC 200 | 2014-2017 2CP079 0129 **** |
| EC 250 | 2010-2011 2CP079 0008 **** |
| EC 250 | 2014-2017 2CP079 0129 **** |
| EC 300 | 2010-2011 2CP079 0008 **** |
| EC 300 | 2014-2017 2CP079 0129 **** |

## HONDA

| YEAR | CODE |
|------|------|
|------|------|

|          |                            |
|----------|----------------------------|
| CRF 150R | 2007-2018 2CP079 0113 **** |
| CRF 250R | 2004-2009 2CP079 0005 **** |
| CRF 250R | 2004-2009 2CP079 005A **** |

## HONDA (contin.)

| YEAR | CODE |
|------|------|
|------|------|

|           |                            |
|-----------|----------------------------|
| CRF 250R  | 2010-2013 2CP079 0064 **** |
| CRF 250R  | 2014-2017 2CP079 0126 **** |
| CRF 250R  | 2018-2019 2CP079 0185 **** |
| CRF 300RX | 2019 2CP079 0185 ****      |
| CRF 250X  | 2004-2017 2CP079 0004 **** |
| CRF 450L  | 2019 2CP079 0195 ****      |
| CRF 450R  | 2005-2008 2CP079 0002 **** |
| CRF 450R  | 2009-2012 2CP079 0049 **** |
| CRF 450R  | 2009-2016 2CP079 0114 **** |
| CRF 450R  | 2017-2019 2CP079 0176 **** |
| CRF 450RX | 2017-2019 2CP079 0176 **** |
| CRF 450X  | 2005-2018 2CP079 0003 **** |

## HUSABERG

| YEAR | CODE |
|------|------|
|------|------|

|        |                            |
|--------|----------------------------|
| TE 125 | 2012-2013 2CP079 0063 **** |
| TE 125 | 2012-2013 2CP079 063B **** |
| FE 250 | 2013 2CP079 0090 ****      |
| TE 250 | 2012 2CP079 0069 ****      |
| TE 250 | 2013 2CP079 0097 ****      |
| TE 300 | 2012 2CP079 0069 ****      |
| TE 300 | 2013 2CP079 0097 ****      |
| FE 350 | 2013 2CP079 0084 ****      |
| FE 350 | 2013 2CP079 084A ****      |
| FE 450 | 2013 2CP079 0137 ****      |
| FE 501 | 2013 2CP079 0137 ****      |

## HUSQVARNA

| YEAR | CODE |
|------|------|
|------|------|

|        |                            |
|--------|----------------------------|
| TC 85  | 2016 2CP079 0154 ****      |
| TE 125 | 2014 2CP079 0132 ****      |
| TX 125 | 2019 2CP079 0187 ****      |
| TE 150 | 2019 2CP079 0187 ****      |
| FC 250 | 2014-2015 2CP079 111A **** |
| FC 250 | 2016-2018 2CP079 0151 **** |
| FC 250 | 2019 2CP079 0188 ****      |
| FE 250 | 2014-2016 2CP079 111A **** |
| FE 250 | 2017-2018 2CP079 0151 **** |
| FE 250 | 2019-2020 2CP079 0201 **** |
| TC 250 | 2011-2013 2CP079 0078 **** |
| TC 250 | 2019 2CP079 0190 ****      |
| TE 250 | 2011-2013 2CP079 0078 **** |
| TE 250 | 2014-2015 2CP079 100A **** |
| TE 250 | 2016 2CP079 0156 ****      |
| TE 250 | 2017-2019 2CP079 167A **** |

## HUSQVARNA (contin.)

| YEAR | CODE |
|------|------|
|------|------|

|         |                            |
|---------|----------------------------|
| TE 250  | 2020 2CP079 0202 ****      |
| TE 300  | 2014-2015 2CP079 100A **** |
| TE 300  | 2016 2CP079 0156 ****      |
| TE 300  | 2017-2019 2CP079 167A **** |
| TE 300  | 2020 2CP079 0202 ****      |
| TE 310  | 2011-2013 2CP079 0078 **** |
| FC 350  | 2014-2015 2CP079 111A **** |
| FC 350  | 2016-2018 2CP079 0151 **** |
| FC 350  | 2019 2CP079 0188 ****      |
| FE 350  | 2014-2016 2CP079 111A **** |
| FE 350  | 2017-2018 2CP079 0151 **** |
| FE 350  | 2019-2020 2CP079 0201 **** |
| FE 350S | 2016 2CP079 111A ****      |
| FC 450  | 2015 2CP079 0144 ****      |
| FC 450  | 2016-2018 2CP079 0153 **** |
| FC 450  | 2019 2CP079 0189 ****      |
| FE 450  | 2015-2016 2CP079 0144 **** |
| FE 450  | 2017-2018 2CP079 0153 **** |
| FE 501  | 2015-2016 2CP079 0144 **** |
| FE 501S | 2016 2CP079 0144 ****      |

## KAWASAKI

| YEAR | CODE |
|------|------|
|------|------|

|          |                            |
|----------|----------------------------|
| KX 85    | 2004-2013 2CP079 0112 **** |
| KX 250 F | 2008 2CP079 0019 ****      |
| KX 250 F | 2010-2015 2CP079 0065 **** |
| KX 250 F | 2010-2019 2CP079 065A **** |
| KX 450 F | 2012-2015 2CP079 0089 **** |
| KX 450 F | 2016-2018 2CP079 0152 **** |
| KX 450 F | 2019 2CP079 0192 ****      |

## KTM

| YEAR | CODE |
|------|------|
|------|------|

|         |                            |
|---------|----------------------------|
| 65 SX   | 2014 2CP079 130A ****      |
| 85 SX   | 2003-2015 2CP079 0104 **** |
| 85 SX   | 2016 2CP079 0154 ****      |
| 125 EXC | 2008-2015 2CP079 0063 **** |
| 125 EXC | 2008-2016 2CP079 063B **** |
| 125 EXC | 2017 2CP079 0187 ****      |
| 125 SX  | 2007-2011 2CP079 0063 **** |
| 125 SX  | 2007-2011 2CP079 063B **** |
| 125 SX  | 2012-2015 2CP079 0107 **** |
| 125 SX  | 2012-2015 2CP079 107A **** |
| 125 SX  | 2016-2018 2CP079 0164 **** |
| 125 SX  | 2019 2CP079 0187 ****      |



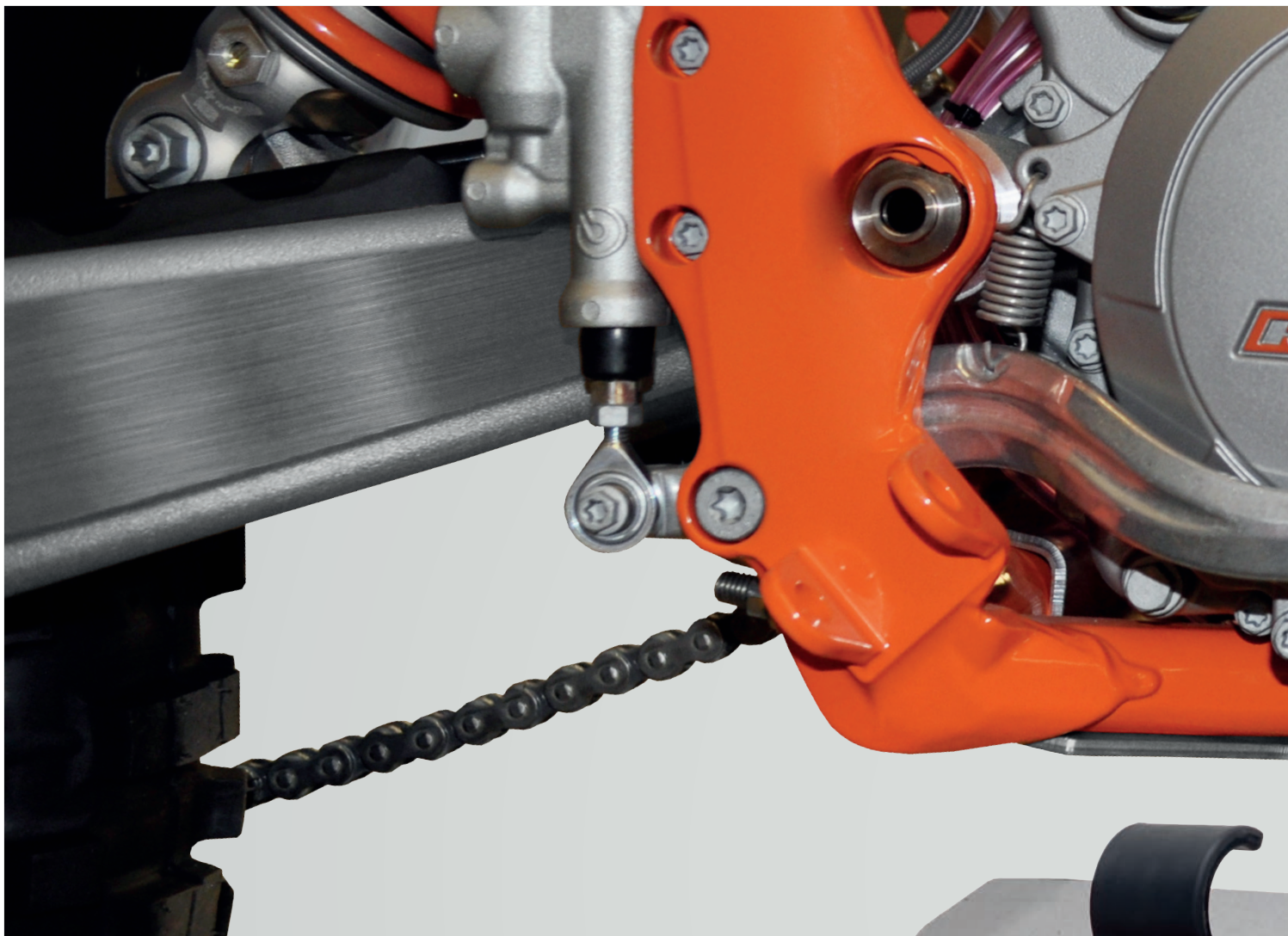

# ENDURO

## ALUMINUM





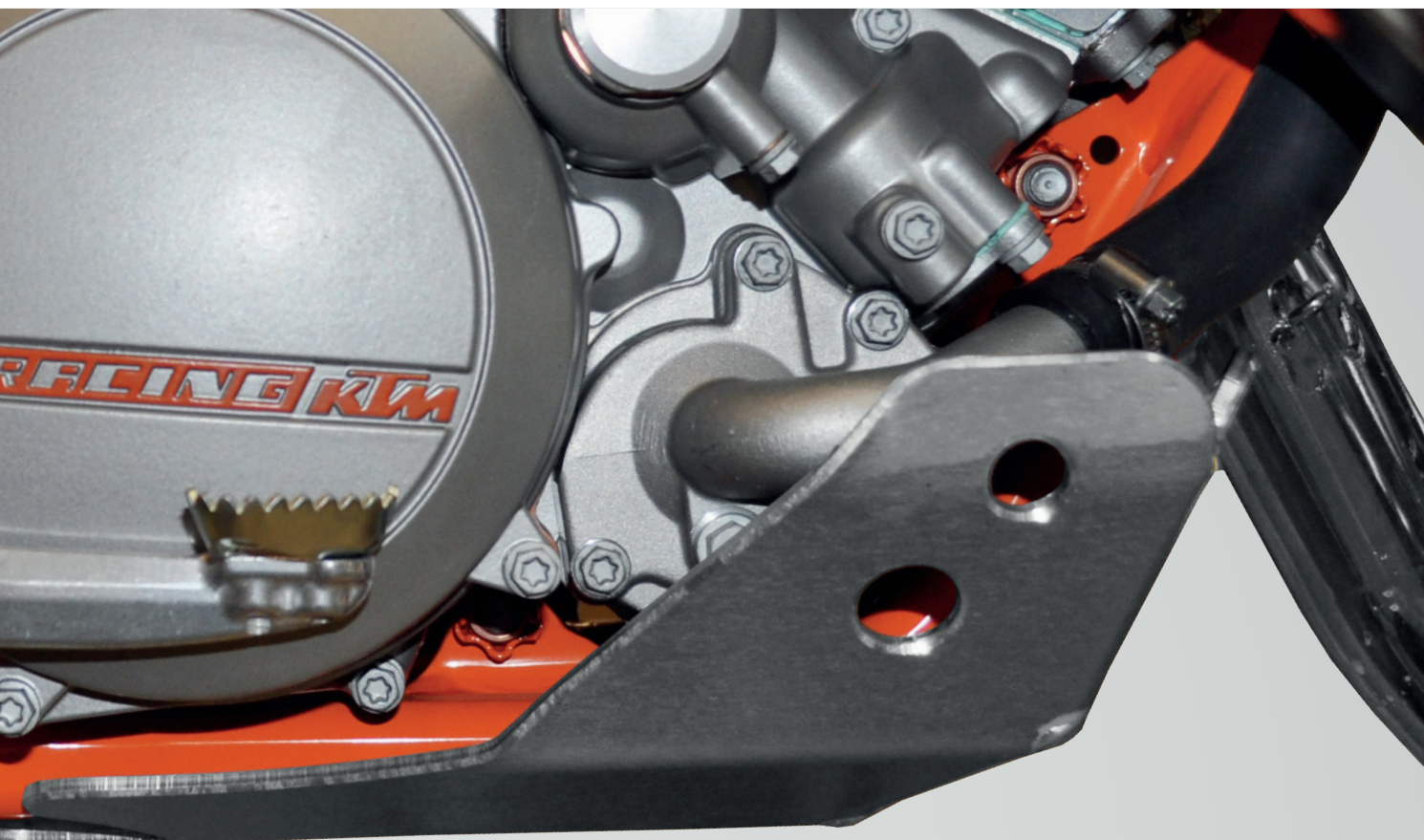

# 25

## ENDURO ALUMINUM



### Enduro aluminum engine guard

//These aluminum skid plates offer the maximum of protection for a minimum weight  
 //They wrap around the bottom and both sides of the engine providing your bike with perfect protection against rocks  
 //Made by best quality aluminum, with a thickness of 4mm

### Protecções de motor enduro em alumínio

//As Protecções de Motor de Enduro da Crosspro oferecem a máxima protecção, sendo extremamente leves  
 //Cobrem totalmente o motor da sua moto, garantindo a máxima protecção contra impactos e projecções de pedras  
 //Produzidas em alumínio da mais alta qualidade, com espessura de 4mm

- » Replace the (\*\*\*\*) for the code of the desired color Example: Red Color 2CP05900510007
- » Substituir os (\*\*\*\*) pelo código de cor pretendida.Exemplo: para a cor vermelha 2CP05900510007

|  |   |   |   |   |   |   |   |   |   |
|--|---|---|---|---|---|---|---|---|---|
|  »0001 |  »0002 |  »0003 |  »0004 |  »0011 |  »0007 |  »0006 |  »0008 |  »0010 |  »0009 |
| Ice Matte  | Polish Polido   | Neutral Natural   | Black Preto   | Blue Azul   | Red Vermelho  | White Branco  | Yellow Amarelo  | Orange Laranja  | Green Verde   |





# 27

» Replace the (\*\*\*\*) for the code of the desired color Example: Red Color 2CP05900510007

» Substituir os (\*\*\*\*) pelo código de cor pretendida: Exemplo: para a cor vermelha 2CP05900510007

- »0001  
Ice Matte  
Ice Polish
- »0002  
Polish  
Polido
- »0003  
Neutral  
Natural
- »0004  
Black  
Preto
- »0011  
Blue  
Azul
- »0007  
Red  
Vermelho
- »0006  
White  
Branco
- »0008  
Yellow  
Amarelo
- »0010  
Orange  
Laranja
- »0009  
Green  
Verde

| KTM (contin.)  | YEAR      | CODE             |
|----------------|-----------|------------------|
| 250 SX-F       | 2010      | 2CP059 0074 **** |
| 250 SX-F       | 2011      | 2CP059 0072 **** |
| 250 SX-F       | 2012      | 2CP059 0090 **** |
| 250 SX-F       | 2013-2014 | 2CP059 0119 **** |
| 250 SX-F       | 2015      | 2CP059 111A **** |
| 250 SX-F       | 2016-2018 | 2CP059 0151 **** |
| 250 SX-F       | 2019      | 2CP059 0188 **** |
| 250 XC         | 2012-2014 | 2CP059 0100 **** |
| 250 XC         | 2019      | 2CP059 0190 **** |
| 250 XC         | 2020      | 2CP059 0202 **** |
| 250 XC-F       | 2016-2018 | 2CP059 0151 **** |
| 250 XC-F       | 2019      | 2CP059 0188 **** |
| 250 XC-W       | 2016      | 2CP059 0133 **** |
| 250 XC-W       | 2017-2018 | 2CP059 0167 **** |
| 250 XC-W       | 2019      | 2CP059 0199 **** |
| 250 XCF-W      | 2016      | 2CP059 122A **** |
| FREERIDE 250 R | 2014-2015 | 2CP059 0146 **** |
| 300 EXC        | 2001-2007 | 2CP059 079A **** |
| 300 EXC        | 2009-2010 | 2CP059 0037 **** |
| 300 EXC        | 2011      | 2CP059 069A **** |
| 300 EXC        | 2012-2016 | 2CP059 0133 **** |
| 300 EXC        | 2017-2018 | 2CP059 0167 **** |
| 300 EXC        | 2019      | 2CP059 0199 **** |
| 300 EXC        | 2020      | 2CP059 0202 **** |
| 300 XC         | 2012-2014 | 2CP059 0100 **** |
| 300 XC         | 2019      | 2CP059 0190 **** |
| 300 XC-W       | 2016      | 2CP059 0133 **** |
| 300 XC-W       | 2017-2018 | 2CP059 0167 **** |
| 300 XC-W       | 2019      | 2CP059 0199 **** |
| 350 EXC-F      | 2012-2014 | 2CP059 0084 **** |
| 350 EXC-F      | 2015-2016 | 2CP059 122A **** |
| 350 EXC-F      | 2017-2019 | 2CP059 0171 **** |
| 350 EXC-F      | 2020      | 2CP059 0201 **** |
| 350 SX-F       | 2011-2015 | 2CP059 0070 **** |
| 350 SX-F       | 2016-2018 | 2CP059 0151 **** |
| 350 SX-F       | 2019      | 2CP059 0188 **** |
| 350 XC-F       | 2012-2014 | 2CP059 111A **** |
| 350 XC-F       | 2016-2018 | 2CP059 0151 **** |
| 350 XC-F       | 2019      | 2CP059 0188 **** |
| 350 XCF-W      | 2016      | 2CP059 122A **** |
| 400 EXC-F      | 2001-2002 | 2CP059 0032 **** |
| 400 EXC-F      | 2004-2007 | 2CP059 0033 **** |
| 400 EXC-F      | 2009-2011 | 2CP059 0030 **** |
| 400 SX-F       | 2000-2002 | 2CP059 0032 **** |
| 450 EXC-F      | 2003      | 2CP059 0032 **** |
| 450 EXC-F      | 2004-2007 | 2CP059 0033 **** |
| 450 EXC-F      | 2008-2011 | 2CP059 0030 **** |
| 450 EXC-F      | 2012-2013 | 2CP059 0085 **** |
| 450 EXC-F      | 2012-2016 | 2CP059 0137 **** |
| 450 EXC-F      | 2017-2019 | 2CP059 0168 **** |

| KTM (contin.) | YEAR      | CODE             |
|---------------|-----------|------------------|
| 450 SX-F      | 2003-2006 | 2CP059 0033 **** |
| 450 SX-F      | 2007-2010 | 2CP059 0031 **** |
| 450 SX-F      | 2011-2012 | 2CP059 0071 **** |
| 450 SX-F      | 2013-2014 | 2CP059 0085 **** |
| 450 SX-F      | 2013-2014 | 2CP059 0137 **** |
| 450 SX-F      | 2016-2018 | 2CP059 0153 **** |
| 450 SX-F      | 2019      | 2CP059 0189 **** |
| 450 XC-F      | 2016-2018 | 2CP059 0153 **** |
| 450 XC-F      | 2019      | 2CP059 0189 **** |
| 450 XC-W      | 2016      | 2CP059 0137 **** |
| 500 EXC-F     | 2012-2013 | 2CP059 0085 **** |
| 500 EXC-F     | 2012-2016 | 2CP059 0137 **** |
| 500 EXC-F     | 2017-2019 | 2CP059 0168 **** |
| 500 XC-W      | 2016      | 2CP059 0137 **** |
| 505 SX-F      | 2007-2008 | 2CP059 0031 **** |
| 525 EXC-F     | 2003      | 2CP059 0032 **** |
| 525 EXC-F     | 2004-2007 | 2CP059 0033 **** |
| 525 SX-F      | 2003-2006 | 2CP059 0033 **** |
| 530 EXC-F     | 2008-2011 | 2CP059 0030 **** |

| SHERCO   | YEAR      | CODE             |
|----------|-----------|------------------|
| SE 125R  | 2018      | 2CP059 0182 **** |
| SE 250R  | 2014-2016 | 2CP059 0099 **** |
| SE 250R  | 2017-2019 | 2CP059 0175 **** |
| SEF 250R | 2012-2014 | 2CP059 0092 **** |
| SEF 250R | 2015-2018 | 2CP059 134A **** |
| SEF 250R | 2019      | 2CP059 0198 **** |
| SE 300R  | 2014-2016 | 2CP059 0099 **** |
| SE 300R  | 2017-2019 | 2CP059 0175 **** |
| SEF 300R | 2012-2014 | 2CP059 0092 **** |
| SEF 300R | 2015-2018 | 2CP059 134A **** |
| SEF 300R | 2019      | 2CP059 0198 **** |

| SUZUKI     | YEAR      | CODE             |
|------------|-----------|------------------|
| RM 85      | 2002-2015 | 2CP059 0106 **** |
| RM-Z 250   | 2007-2009 | 2CP059 0009 **** |
| RM-Z 250   | 2010-2013 | 2CP059 0059 **** |
| RM-Z 250   | 2010-2014 | 2CP059 059A **** |
| RM-Z 250   | 2015      | 2CP059 0138 **** |
| RM-Z 250   | 2016      | 2CP059 0160 **** |
| RM-Z 250   | 2017-2018 | 2CP059 0172 **** |
| DR-Z 400   | 2000-2004 | 2CP059 0068 **** |
| DR-Z 400E  | 2000-2007 | 2CP059 0068 **** |
| DR-Z 400S  | 2000-2015 | 2CP059 0068 **** |
| DR-Z 400SM | 2005-2009 | 2CP059 0068 **** |
| DR-Z 400SM | 2013-2015 | 2CP059 0068 **** |
| RM-Z 450   | 2005-2007 | 2CP059 0010 **** |
| RM-Z 450   | 2008-2009 | 2CP059 0011 **** |
| RM-Z 450   | 2010-2015 | 2CP059 058A **** |
| RM-Z 450   | 2016-2017 | 2CP059 0161 **** |
| RM-Z 450   | 2018      | 2CP059 0186 **** |

| SUZUKI (contin.) | YEAR      | CODE             |
|------------------|-----------|------------------|
| RMX 450Z         | 2010-2011 | 2CP059 0060 **** |
| RMX 450Z         | 2017-2018 | 2CP059 0060 **** |

| TM         | YEAR      | CODE             |
|------------|-----------|------------------|
| MX 85      | 2015      | 2CP059 0166 **** |
| EN 125     | 2008-2015 | 2CP059 0041 **** |
| EN 125     | 2016-2019 | 2CP059 0158 **** |
| MX 125     | 2008-2015 | 2CP059 0041 **** |
| MX 125     | 2016-2019 | 2CP059 0158 **** |
| EN 144     | 2009-2015 | 2CP059 0041 **** |
| EN 144     | 2016-2019 | 2CP059 0158 **** |
| MX 144     | 2008-2015 | 2CP059 0041 **** |
| MX 144     | 2016-2019 | 2CP059 0158 **** |
| EN/MX 250  | 2004-2007 | 2CP059 0022 **** |
| EN/MX 250  | 2008-2010 | 2CP059 0038 **** |
| EN/MX 250  | 2011-2014 | 2CP059 0125 **** |
| EN/MX 250  | 2015      | 2CP059 0147 **** |
| EN/MX 250  | 2016-2018 | 2CP059 0155 **** |
| EN/MX 250  | 2019      | 2CP059 0194 **** |
| EN 250F    | 2008-2010 | 2CP059 0050 **** |
| EN 250F    | 2011-2014 | 2CP059 0159 **** |
| EN 250F    | 2015      | 2CP059 0148 **** |
| EN 250F    | 2016      | 2CP059 0170 **** |
| MX 250F    | 2008-2010 | 2CP059 0050 **** |
| EN/MX 300  | 2004-2007 | 2CP059 0022 **** |
| EN/MX 300  | 2008-2010 | 2CP059 0038 **** |
| EN/MX 300  | 2011-2014 | 2CP059 0125 **** |
| EN/MX 300  | 2015      | 2CP059 0147 **** |
| EN/MX 300  | 2016-2018 | 2CP059 0155 **** |
| EN/MX 300  | 2019      | 2CP059 0194 **** |
| EN/MX 450F | 2008-2014 | 2CP059 0050 **** |
| EN/MX 530F | 2008-2014 | 2CP059 0050 **** |

| YAMAHA   | YEAR      | CODE             |
|----------|-----------|------------------|
| YZ 85    | 2004-2018 | 2CP059 0110 **** |
| WR 250 F | 2007-2014 | 2CP059 0014 **** |
| WR 250 F | 2015-2019 | 2CP059 0145 **** |
| YZ 250   | 2005-2019 | 2CP059 0017 **** |
| YZ 250 F | 2006-2009 | 2CP059 0138 **** |
| YZ 250 F | 2010-2013 | 2CP059 0054 **** |
| YZ 250 F | 2014-2018 | 2CP059 0128 **** |
| YZ 250 F | 2019      | 2CP059 0193 **** |
| WR 450 F | 2003-2006 | 2CP059 0066 **** |
| WR 450 F | 2007-2011 | 2CP059 0015 **** |
| WR 450 F | 2012-2015 | 2CP059 0098 **** |
| WR 450 F | 2016-2018 | 2CP059 0163 **** |
| WR 450 F | 2019      | 2CP059 0180 **** |
| YZ 450 F | 2006-2009 | 2CP059 0018 **** |
| YZ 450 F | 2010-2013 | 2CP059 0061 **** |
| YZ 450 F | 2014-2017 | 2CP059 0124 **** |
| YZ 450 F | 2018-2019 | 2CP059 0180 **** |

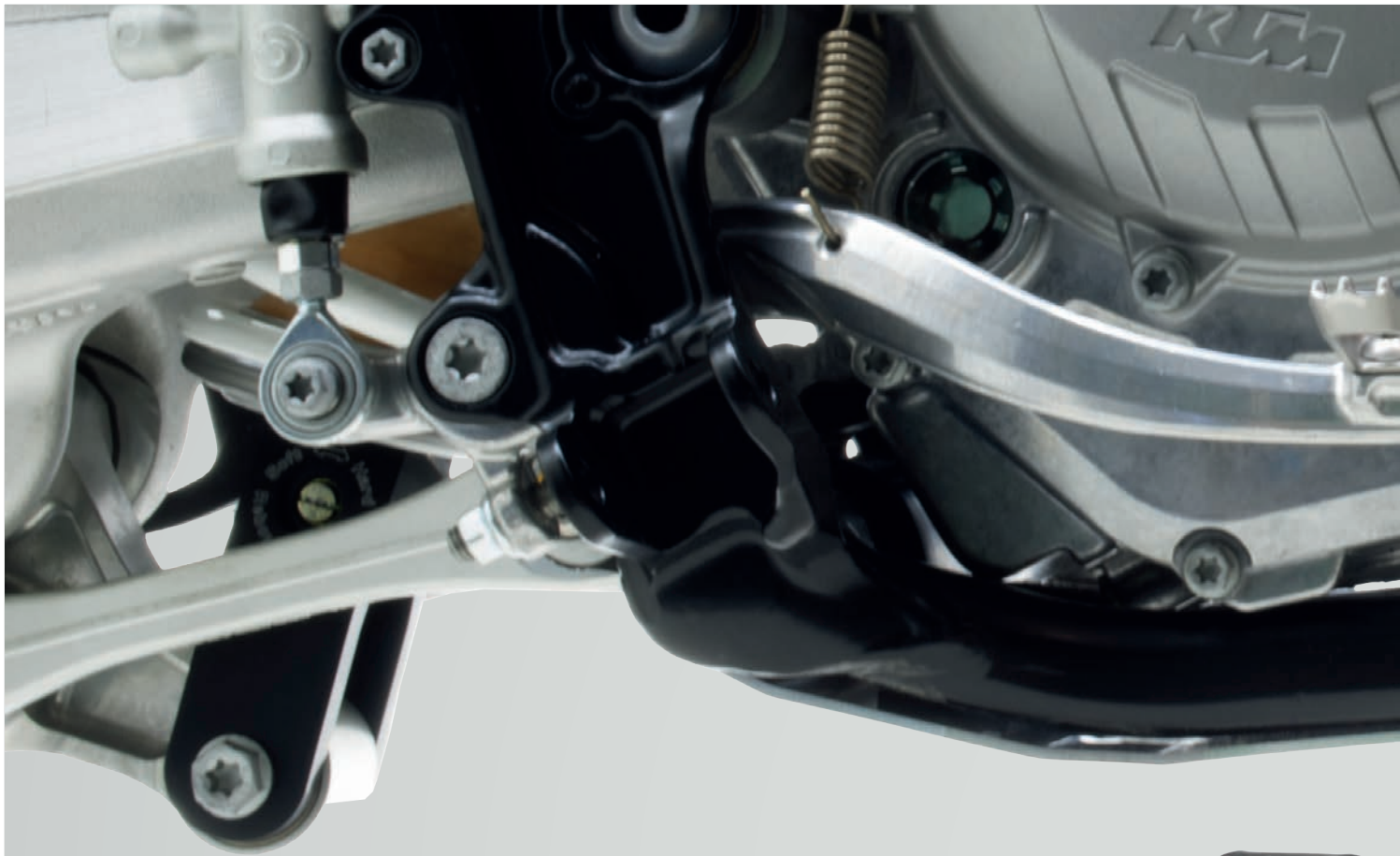

# MX ALUMINUM





# 29

**MX**  
**ALUMINUM**



### Motocross aluminum engine guard

//CrossPro motocross and supermoto plates give your engine and lower frame, the protection they need helping you glide over obstacles

//Our coverage, simplicity of mounting, and product finally quality are the reasons why you should equip your bike with CrossPro glide

//Made by best quality aluminum, with a thickness of 4mm

### Protecções de motor motocross em alumínio

//As protecções de motor CrossPro de Motocross e Supermoto, asseguram a máxima protecção ao seu motor, permitindo deslizar sobre todos os obstáculos

//As protecções protegem também a parte inferior do quadro da moto.

//A máxima protecção, a simplicidade de montagem e a qualidade final do produto, são as principais razões pelas quais deverá equipar a sua moto com as protecções de motor CrossPro

//Produzidas em alumínio da mais alta qualidade, com espessura de 4mm

» Replace the (\*\*\*\*) for the code of the desired color Example: Red Color 2CP0610051\*\*\*\*

» Substituir os (\*\*\*\*) pelo código de cor pretendida.Exemplo: para a cor vermelha 2CP0610051\*\*\*\*

|  |   |   |   |   |   |   |   |   |   |
|--|---|---|---|---|---|---|---|---|---|
|  »0001 |  »0002 |  »0003 |  »0004 |  »0011 |  »0007 |  »0006 |  »0008 |  »0010 |  »0009 |
| Ice Matte  | Polish Polido   | Neutral Natural   | Black Preto   | Blue Azul   | Red Vermelho  | White Branco  | Yellow Amarelo  | Orange Laranja  | Green Verde   |



# MX ALUMINUM

# 31



» Replace the (\*\*\*\*) for the code of the desired color Example: Red Color 2CP06100510007

» Substituir os (\*\*\*\*) pelo código de cor pretendida: Exemplo: para a cor vermelha 2CP06100510007



| KTM (contin.) | YEAR      | CODE             |
|---------------|-----------|------------------|
| 400 EXC-F     | 2004-2007 | 2CP061 0033 **** |
| 400 EXC-F     | 2009-2011 | 2CP061 0030 **** |
| 400 SX-F      | 2000-2002 | 2CP061 0032 **** |
| 450 EXC-F     | 2003      | 2CP061 0032 **** |
| 450 EXC-F     | 2004-2007 | 2CP061 0033 **** |
| 450 EXC-F     | 2008-2011 | 2CP061 0030 **** |
| 450 EXC-F     | 2012-2016 | 2CP061 0137 **** |
| 450 EXC-F     | 2017-2019 | 2CP061 0168 **** |
| 450 SX-F      | 2003-2006 | 2CP061 0033 **** |
| 450 SX-F      | 2007-2010 | 2CP061 0031 **** |
| 450 SX-F      | 2011-2012 | 2CP061 0071 **** |
| 450 SX-F      | 2013-2014 | 2CP061 0137 **** |
| 450 SX-F      | 2016-2018 | 2CP061 0153 **** |
| 450 SX-F      | 2019      | 2CP061 0189 **** |
| 450 XC-F      | 2016-2018 | 2CP061 0153 **** |
| 450 XC-F      | 2019      | 2CP061 0189 **** |
| 450 XC-W      | 2016      | 2CP061 0137 **** |
| 500 EXC-F     | 2012-2016 | 2CP061 0137 **** |
| 500 EXC-F     | 2017-2019 | 2CP061 0168 **** |
| 500 XC-W      | 2016      | 2CP061 0137 **** |
| 505 SX-F      | 2007-2008 | 2CP061 0031 **** |
| 525 EXC-F     | 2003      | 2CP061 0032 **** |
| 525 EXC-F     | 2004-2007 | 2CP061 0033 **** |
| 525 SX-F      | 2003-2006 | 2CP061 0033 **** |
| 530 EXC-F     | 2008-2011 | 2CP061 0030 **** |

| SHERCO   | YEAR      | CODE             |
|----------|-----------|------------------|
| SE 250R  | 2014-2016 | 2CP061 0099 **** |
| SE 250R  | 2017-2018 | 2CP061 0175 **** |
| SEF 250R | 2012-2014 | 2CP061 0092 **** |
| SE 300R  | 2014-2016 | 2CP061 0099 **** |
| SE 300R  | 2017-2018 | 2CP061 0175 **** |
| SEF 300R | 2012-2014 | 2CP061 0092 **** |

| SUZUKI     | YEAR      | CODE             |
|------------|-----------|------------------|
| RM 85      | 2002-2015 | 2CP061 0106 **** |
| RM-Z 250   | 2007-2009 | 2CP061 0009 **** |
| RM-Z 250   | 2010-2014 | 2CP061 059A **** |
| RM-Z 250   | 2015      | 2CP061 0138 **** |
| RM-Z 250   | 2016      | 2CP061 0160 **** |
| RM-Z 250   | 2017-2018 | 2CP061 0172 **** |
| DR-Z 400   | 2000-2004 | 2CP061 0068 **** |
| DR-Z 400E  | 2000-2007 | 2CP061 0068 **** |
| DR-Z 400S  | 2000-2015 | 2CP061 0068 **** |
| DR-Z 400SM | 2005-2009 | 2CP061 0068 **** |
| DR-Z 400SM | 2013-2015 | 2CP061 0068 **** |
| RM-Z 450   | 2005-2007 | 2CP061 0010 **** |
| RM-Z 450   | 2008-2009 | 2CP061 0011 **** |
| RM-Z 450   | 2010-2013 | 2CP061 0058 **** |
| RM-Z 450   | 2010-2015 | 2CP061 058A **** |
| RM-Z 450   | 2016-2017 | 2CP061 0161 **** |
| RM-Z 450   | 2018      | 2CP061 0186 **** |
| RMX 450Z   | 2010-2011 | 2CP061 0060 **** |
| RMX 450Z   | 2017-2018 | 2CP061 0060 **** |

| TM        | YEAR      | CODE             |
|-----------|-----------|------------------|
| EN 125    | 2008-2015 | 2CP061 0041 **** |
| EN 125    | 2016-2019 | 2CP061 0158 **** |
| MX 125    | 2008-2015 | 2CP061 0041 **** |
| MX 125    | 2016-2019 | 2CP061 0158 **** |
| EN 144    | 2009-2015 | 2CP061 0041 **** |
| EN 144    | 2016-2019 | 2CP061 0158 **** |
| MX 144    | 2008-2015 | 2CP061 0041 **** |
| MX 144    | 2016-2019 | 2CP061 0158 **** |
| EN/MX 250 | 2004-2007 | 2CP061 0022 **** |
| EN/MX 250 | 2008-2010 | 2CP061 0038 **** |
| EN/MX 250 | 2011-2014 | 2CP061 0125 **** |
| EN/MX 250 | 2015      | 2CP061 0147 **** |

| TM (contin.) | YEAR      | CODE             |
|--------------|-----------|------------------|
| EN/MX 250    | 2016-2018 | 2CP061 0155 **** |
| EN/MX 250    | 2019      | 2CP061 0194 **** |
| EN 250F      | 2008-2010 | 2CP061 0050 **** |
| EN 250F      | 2011-2014 | 2CP061 0159 **** |
| EN 250F      | 2015      | 2CP061 0148 **** |
| MX 250F      | 2008-2014 | 2CP061 0050 **** |
| EN/MX 300    | 2004-2007 | 2CP061 0022 **** |
| EN/MX 300    | 2008-2010 | 2CP061 0038 **** |
| EN/MX 300    | 2011-2014 | 2CP061 0125 **** |
| EN/MX 300    | 2015      | 2CP061 0147 **** |
| EN/MX 300    | 2016-2018 | 2CP061 0155 **** |
| EN/MX 300    | 2019      | 2CP061 0194 **** |
| EN/MX 450F   | 2008-2014 | 2CP061 0050 **** |
| EN/MX 530F   | 2008-2014 | 2CP061 0050 **** |

| YAMAHA   | YEAR      | CODE             |
|----------|-----------|------------------|
| WR 250 F | 2007-2014 | 2CP061 0014 **** |
| WR 250 F | 2015-2019 | 2CP061 0145 **** |
| YZ 250   | 2005-2019 | 2CP061 0017 **** |
| YZ 250 F | 2006-2009 | 2CP061 0016 **** |
| YZ 250 F | 2010-2013 | 2CP061 0054 **** |
| YZ 250 F | 2014-2018 | 2CP061 0128 **** |
| YZ 250 F | 2019      | 2CP061 0193 **** |
| WR 450 F | 2003-2006 | 2CP061 0066 **** |
| WR 450 F | 2007-2011 | 2CP061 0015 **** |
| WR 450 F | 2012-2015 | 2CP061 0098 **** |
| WR 450 F | 2016-2018 | 2CP061 0163 **** |
| WR 450 F | 2019      | 2CP061 0180 **** |
| YZ 450 F | 2006-2009 | 2CP061 0018 **** |
| YZ 450 F | 2010-2013 | 2CP061 0061 **** |
| YZ 450 F | 2014-2017 | 2CP061 0124 **** |
| YZ 450 F | 2018-2019 | 2CP061 0180 **** |



**RADIATOR GUARD**  
**ALUMINUM**



# RADIATOR GUARD ALUMINUM



RADIATOR GUARD  
ALUMINUM

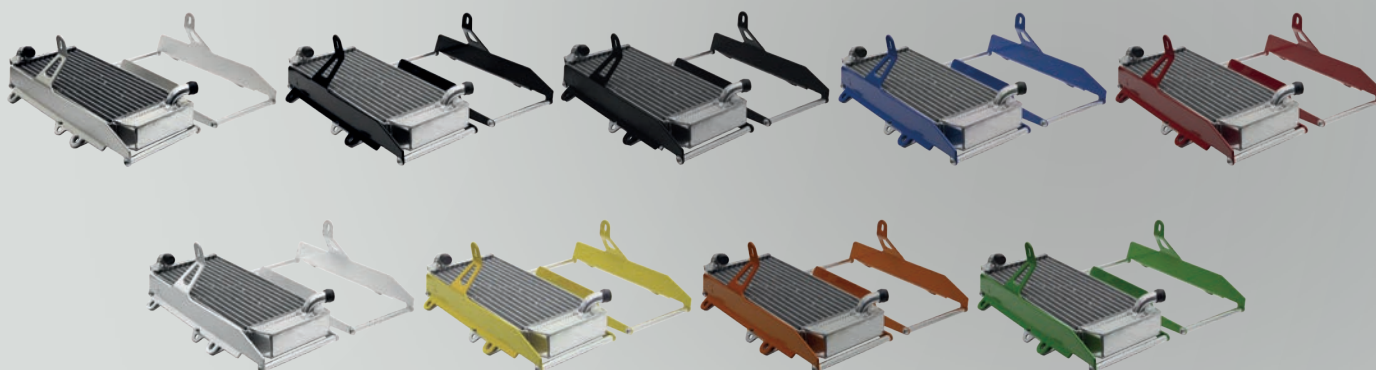









## Radiator aluminum guard

//The CrossPro radiator were specially designed to protect your Cooling System, your bike's most fragile and important component - without obstructing airflow to the radiator  
 //Designed as a "radiator roll cage", the CrossPro radiator protection secures a perimeter around the radiator, without its fixation points are in direct contact with the radiator  
 //With this security perimeter, hard impacts won't affect your radiator  
 //Made by best quality aluminum, with a thickness of 3mm

## Protecções de radiador em alumínio

//As protecções de radiador Light CrossPro foram desenvolvidas para proteger o sistema de refrigeração (a parte mais frágil e importante da sua moto). Não obstrui o fluxo de ar necessário para o devido arrefecimento  
 //Desenhado como uma espécie de "Concha", a protecção de radiador assegura um perímetro de segurança, sem que os seus pontos de fixação estejam em contacto directo com o radiador. A fixação é efectuada ao quadro da moto.  
 //Com este perímetro de segurança, os impactos nunca serão transmitidos directamente ao radiador  
 //Produzidas em alumínio da mais alta qualidade, com espessura de 3mm.

- » Replace the (\*\*\*\*) for the code of the desired color Example: Red Color 2CP06000510007
- » Substituir os (\*\*\*\*) pelo código de cor pretendida.Exemplo: para a cor vermelha 2CP06000510007

|   |   |   |   |   |   |  |   |
|---|---|---|---|---|---|--|---|
|  »0001 |  »0004 |  »0011 |  »0007 |  »0006 |  »0008 |  »0010 |  »0009 |
| Ice Matte<br>Ice Polish   | Black<br>Preto  | Blue<br>Azul  | Red<br>Vermelho   | White<br>Branco   | Yellow<br>Amarelo   | Orange<br>Laranja  | Green<br>Verde  |







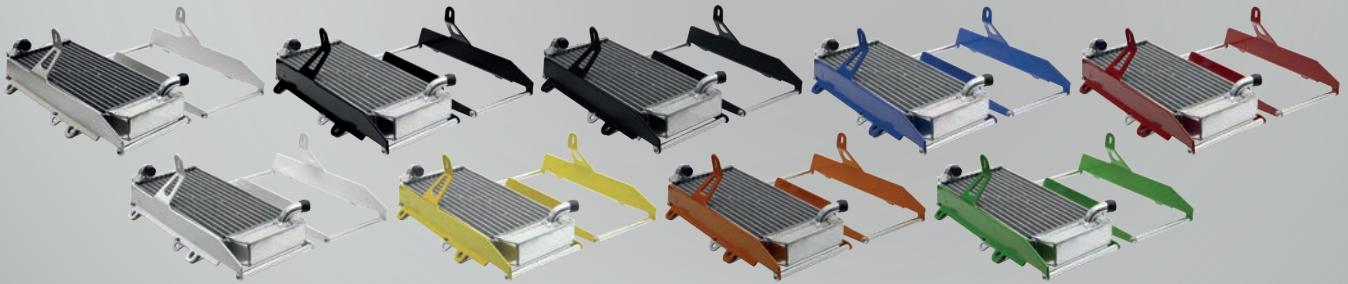



# RADIATOR GUARD ALUMINUM

# 35



» Replace the (\*\*\*\*) for the code of the desired color Example: Red Color 2CP060005**10007**

» Substituir os (\*\*\*\*) pelo código de cor pretendida:Exemplo: para a cor vermelha 2CP060005**10007**

|   |   |   |   |   |   |  |   |
|---|---|---|---|---|---|--|---|
|  »0001 |  »0004 |  »0011 |  »0007 |  »0006 |  »0008 |  »0010 |  »0009 |
| Ice Matte   | Black Preto   | Blue Azul   | Red Vermelho  | White Branco  | Yellow Amarelo  | Orange Laranja   | Green Verde   |

| KTM (contin.)                          | YEAR      | CODE                    |
|--|-----------|-------------------------|
| 450 EXC-F With Fan / Com Ventilador    | 2017-2019 | 2CP060 <b>0168</b> **** |
| 450 EXC-F Without Fan / Sem Ventilador | 2017-2019 | 2CP060 <b>0167</b> **** |
| 450 SX-F                               | 2005-2006 | 2CP060 <b>0033</b> **** |
| 450 SX-F                               | 2007-2010 | 2CP060 <b>087B</b> **** |
| 450 SX-F                               | 2011-2014 | 2CP060 <b>0141</b> **** |
| 450 SX-F                               | 2015      | 2CP060 <b>140A</b> **** |
| 450 SX-F                               | 2016-2018 | 2CP060 <b>0151</b> **** |
| 450 SX-F                               | 2019      | 2CP060 <b>188A</b> **** |
| 450 XC-F                               | 2013-2014 | 2CP060 <b>0141</b> **** |
| 450 XC-F                               | 2015      | 2CP060 <b>140A</b> **** |
| 450 XC-F                               | 2016-2018 | 2CP060 <b>0151</b> **** |
| 450 XC-F                               | 2019      | 2CP060 <b>188A</b> **** |
| 450 XC-W                               | 2015-2016 | 2CP060 <b>140A</b> **** |
| 500 EXC-F                              | 2012-2016 | 2CP060 <b>140A</b> **** |
| 500 EXC-F With Fan / Com Ventilador    | 2017-2019 | 2CP060 <b>0168</b> **** |
| 500 EXC-F Without Fan / Sem Ventilador | 2017-2019 | 2CP060 <b>0167</b> **** |
| 500 XC-W                               | 2015-2016 | 2CP060 <b>140A</b> **** |
| 505 SX-F                               | 2008      | 2CP060 <b>087B</b> **** |
| 525 EXC-F                              | 2005-2007 | 2CP060 <b>0033</b> **** |
| 525 SX-F                               | 2005-2006 | 2CP060 <b>0033</b> **** |
| 530 EXC-F                              | 2008-2011 | 2CP060 <b>087B</b> **** |

| SHERCO   | YEAR      | CODE                    |
|----------|-----------|-------------------------|
| SE 125R  | 2018      | 2CP060 <b>175A</b> **** |
| SE 250R  | 2014-2016 | 2CP060 <b>0099</b> **** |
| SE 250R  | 2017      | 2CP060 <b>0175</b> **** |
| SE 250R  | 2017-2018 | 2CP060 <b>175A</b> **** |
| SE 250R  | 2019      | 2CP060 <b>0197</b> **** |
| SEF 250R | 2012-2014 | 2CP060 <b>092A</b> **** |
| SEF 250R | 2015-2016 | 2CP060 <b>134A</b> **** |
| SEF 250R | 2015-2018 | 2CP060 <b>134B</b> **** |
| SEF 250R | 2019      | 2CP060 <b>0197</b> **** |
| SE 300R  | 2014-2016 | 2CP060 <b>0099</b> **** |
| SE 300R  | 2017      | 2CP060 <b>0175</b> **** |
| SE 300R  | 2017-2018 | 2CP060 <b>175A</b> **** |
| SE 300R  | 2019      | 2CP060 <b>0197</b> **** |
| SEF 300R | 2012-2014 | 2CP060 <b>092A</b> **** |

| SHERCO (contin.) | YEAR      | CODE                    |
|------------------|-----------|-------------------------|
| SEF 300R         | 2015-2016 | 2CP060 <b>134A</b> **** |
| SEF 300R         | 2015-2018 | 2CP060 <b>134B</b> **** |
| SEF 300R         | 2019      | 2CP060 <b>0197</b> **** |

| SUZUKI     | YEAR      | CODE                    |
|------------|-----------|-------------------------|
| RM 85      | 2002-2016 | 2CP060 <b>0106</b> **** |
| RM-Z 250   | 2007-2009 | 2CP060 <b>0009</b> **** |
| RM-Z 250   | 2010-2013 | 2CP060 <b>0059</b> **** |
| RM-Z 250   | 2010-2018 | 2CP060 <b>059A</b> **** |
| DR-Z 400   | 2000-2004 | 2CP060 <b>0068</b> **** |
| DR-Z 400E  | 2000-2007 | 2CP060 <b>0068</b> **** |
| DR-Z 400S  | 2000-2015 | 2CP060 <b>0068</b> **** |
| DR-Z 400SM | 2005-2009 | 2CP060 <b>0068</b> **** |
| DR-Z 400SM | 2013-2015 | 2CP060 <b>0068</b> **** |
| RM-Z 450   | 2005-2007 | 2CP060 <b>0010</b> **** |
| RM-Z 450   | 2008-2009 | 2CP060 <b>0011</b> **** |
| RM-Z 450   | 2010-2013 | 2CP060 <b>0058</b> **** |
| RM-Z 450   | 2010-2017 | 2CP060 <b>058A</b> **** |
| RM-Z 450   | 2018      | 2CP060 <b>0186</b> **** |
| RMX 450Z   | 2010-2011 | 2CP060 <b>058A</b> **** |
| RMX 450Z   | 2017-2018 | 2CP060 <b>058A</b> **** |

| TM     | YEAR      | CODE                    |
|--------|-----------|-------------------------|
| MX 85  | 2015      | 2CP060 <b>0166</b> **** |
| EN 125 | 2004-2007 | 2CP060 <b>0022</b> **** |
| EN 125 | 2008-2014 | 2CP060 <b>0041</b> **** |
| EN 125 | 2015      | 2CP060 <b>0147</b> **** |
| EN 125 | 2016-2019 | 2CP060 <b>0158</b> **** |
| MX 125 | 2004-2007 | 2CP060 <b>0022</b> **** |
| MX 125 | 2008-2014 | 2CP060 <b>0041</b> **** |
| MX 125 | 2015      | 2CP060 <b>0147</b> **** |
| MX 125 | 2016-2019 | 2CP060 <b>0158</b> **** |
| EN 144 | 2009-2014 | 2CP060 <b>0041</b> **** |
| EN 144 | 2015      | 2CP060 <b>0147</b> **** |
| EN 144 | 2016-2019 | 2CP060 <b>0158</b> **** |
| MX 144 | 2008-2014 | 2CP060 <b>0041</b> **** |
| MX 144 | 2015      | 2CP060 <b>0147</b> **** |
| MX 144 | 2016-2019 | 2CP060 <b>0158</b> **** |

| TM (contin.) | YEAR      | CODE                    |
|--------------|-----------|-------------------------|
| EN/MX 250    | 2004-2007 | 2CP060 <b>0022</b> **** |
| EN/MX 250    | 2008-2014 | 2CP060 <b>0041</b> **** |
| EN/MX 250    | 2015      | 2CP060 <b>0147</b> **** |
| EN/MX 250    | 2016-2018 | 2CP060 <b>0155</b> **** |
| EN/MX 250    | 2019      | 2CP060 <b>0194</b> **** |
| EN 250F      | 2009-2010 | 2CP060 <b>0050</b> **** |
| EN 250F      | 2011-2014 | 2CP060 <b>0159</b> **** |
| EN 250F      | 2015-2016 | 2CP060 <b>0148</b> **** |
| MX 250F      | 2009-2014 | 2CP060 <b>0050</b> **** |
| EN/MX 300    | 2004-2007 | 2CP060 <b>0022</b> **** |
| EN/MX 300    | 2008-2014 | 2CP060 <b>0041</b> **** |
| EN/MX 300    | 2015      | 2CP060 <b>0147</b> **** |
| EN/MX 300    | 2016-2018 | 2CP060 <b>0155</b> **** |
| EN/MX 300    | 2019      | 2CP060 <b>0194</b> **** |
| EN/MX 450F   | 2009-2014 | 2CP060 <b>0050</b> **** |
| EN/MX 530F   | 2009-2014 | 2CP060 <b>0050</b> **** |

| YAMAHA   | YEAR      | CODE                    |
|----------|-----------|-------------------------|
| YZ 65    | 2018-2019 | 2CP060 <b>0200</b> **** |
| YZ 85    | 2004-2018 | 2CP060 <b>0110</b> **** |
| YZ 125   | 2005-2018 | 2CP060 <b>0017</b> **** |
| WR 250 F | 2007-2014 | 2CP060 <b>0014</b> **** |
| WR 250 F | 2015      | 2CP060 <b>0145</b> **** |
| WR 250 F | 2015-2019 | 2CP060 <b>145A</b> **** |
| YZ 250   | 2005-2019 | 2CP060 <b>0017</b> **** |
| YZ 250 F | 2006-2009 | 2CP060 <b>0016</b> **** |
| YZ 250 F | 2010-2013 | 2CP060 <b>054A</b> **** |
| YZ 250 F | 2014-2018 | 2CP060 <b>0124</b> **** |
| YZ 250 F | 2019      | 2CP060 <b>180A</b> **** |
| WR 450 F | 2003-2006 | 2CP060 <b>0066</b> **** |
| WR 450 F | 2007-2011 | 2CP060 <b>0014</b> **** |
| WR 450 F | 2008-2010 | 2CP060 <b>0015</b> **** |
| WR 450 F | 2012-2015 | 2CP060 <b>0098</b> **** |
| WR 450 F | 2016-2018 | 2CP060 <b>0163</b> **** |
| WR 450 F | 2019      | 2CP060 <b>180A</b> **** |
| YZ 450 F | 2006-2009 | 2CP060 <b>0018</b> **** |
| YZ 450 F | 2010-2013 | 2CP060 <b>061A</b> **** |
| YZ 450 F | 2014-2017 | 2CP060 <b>0124</b> **** |
| YZ 450 F | 2018-2019 | 2CP060 <b>180A</b> **** |



Rita Vieira

# ALUMINUM

|                   |           |                |                |
|-------------------|-----------|----------------|----------------|
| <b>GAS GAS</b>    | YEAR      | ● ICE POLISH   | ● BLACK        |
| All (125 a 450cc) | 2000-2009 | 2CP07400080001 | 2CP07400080004 |
| <b>HONDA</b>      | YEAR      | ● ICE POLISH   | ● BLACK        |
| All (125 a 450cc) | 2002-2019 | 2CP07400640001 | 2CP07400640004 |
| <b>KAWASAKI</b>   | YEAR      | ● ICE POLISH   | ● BLACK        |
| All (125 a 450cc) | 2005-2019 | 2CP07400650001 | 2CP07400650004 |
| <b>SUZUKI</b>     | YEAR      | ● ICE POLISH   | ● BLACK        |
| 125 RM            | 2005-2008 | 2CP07400590001 | 2CP07400590004 |
| 250 RM            | 2005-2008 | 2CP07400590001 | 2CP07400590004 |
| 250 RM-Z          | 2007-2018 | 2CP07400590001 | 2CP07400590004 |
| 450 RM-X          | 2010-2017 | 2CP07400590001 | 2CP07400590004 |
| 450 RM-Z          | 2005-2018 | 2CP07400590001 | 2CP07400590004 |
| <b>YAMAHA</b>     | YEAR      | ● ICE POLISH   | ● BLACK        |
| All (125 a 450cc) | 1999-2019 | 2CP074061A0001 | 2CP074061A0004 |



• Aluminum 5mm

# BRAKE DISC GUARDS

## Rear disc guard

//The CrossPro Rear Disc Guards, were developed in order to assure extra protection to your motorcycle, preventing the damages.

//The protections were designed to assure:

- Extra protection
- Easy cleaning
- Design Awareness

//Material:

- Aluminum 5mm available in Ice Polish Black
- DTC 15mm



## Protecções de disco traseiro

//As Protecções de Disco Traseiras, foram desenvolvidas de forma a assegurar protecção extra para a sua mota, prevenindo danos.

//As protecções foram desenhadas para assegurar:

- Protecção Extra
- Limpeza fácil
- Design atraente

//Material:

- Alumínio de 5mm, disponível em IcePolish ou Preto
- DTC de 15mm.

# 37

# DTC

|                   |       |                |
|-------------------|-------|----------------|
| <b>GAS GAS</b>    | YEAR  | ● BLACK        |
| All (125 a 450cc) | 00-09 | 2CP09200080300 |
|                   | 10-18 | 2CP09201790301 |
| <b>HONDA</b>      | YEAR  | ● BLACK        |
| All (125 a 450cc) | 02-19 | 2CP09200640300 |
| <b>HUSQVARNA</b>  | YEAR  | ● BLACK        |
| FE/FX/TE/TX       | 14-17 | 2CP074139A0301 |
| FE/FX/TE/TX       | 18-20 | 2CP09201870301 |
| FC/TC/FS          | 14-19 | 2CP074139A0301 |
| <b>KAWASAKI</b>   | YEAR  | ● BLACK        |
| All (125 a 450cc) | 05-19 | 2CP092065A0300 |
| <b>KTM</b>        | YEAR  | ● BLACK        |
| All SX/EXC        | 04-20 | 2CP074139A0301 |
| <b>SHERCO</b>     | YEAR  | ● BLACK        |
| SE/SEF 125-450    | 15-19 | 2CP074139A0301 |
| <b>SUZUKI</b>     | YEAR  | ● BLACK        |
| 125 RM            | 05-08 | 2CP09200590300 |
| 250 RM            | 05-08 | 2CP09200590300 |
| 250 RM-Z          | 07-18 | 2CP09200590300 |
| 450 RM-X          | 10-17 | 2CP09200590300 |
| 450 RM-Z          | 05-18 | 2CP09200590300 |
| <b>YAMAHA</b>     | YEAR  | ● BLACK        |
| All (125 a 450cc) | 99-19 | 2CP092061B0300 |



Sofia Porfirio

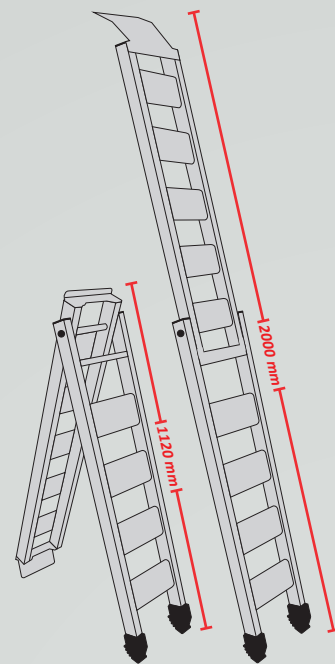

-Supported weight: 240kg  
-Peso soportado: 240kg



[www.crosspro.pt](http://www.crosspro.pt)

**WORKSHOP**

**FOLDING BIKE RAMP**

- |                               |                |
|-------------------------------|----------------|
| ○ Ice Matte folding bike ramp | 2CP083001A0001 |
| ● Black folding bike ramp     | 2CP083001A0004 |
| ○ White folding bike ramp     | 2CP083001A0006 |
| ● Red folding bike ramp       | 2CP083001A0007 |
| ● Yellow folding bike ramp    | 2CP083001A0008 |
| ● Green folding bike ramp     | 2CP083001A0009 |
| ● Orange folding bike ramp    | 2CP083001A0010 |
| ● Blue folding bike ramp      | 2CP083001A0011 |



# ACCESSORIES

# 39



**EXHAUST** **CARBON EXHAUST PROTECTION**

Universal 2CP07300040000

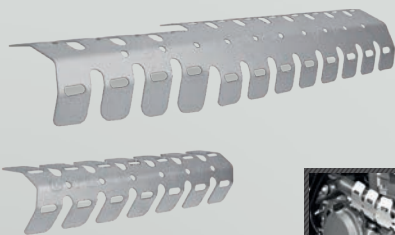

**EXHAUST** **ALUMINUM EXHAUST PROTECTION**

4 Stroke / 4 tempos 2CP07300020001  
2 Stroke / 2 tempos 2CP07300010001

- 49,6 mm >> CH01
- 50,6 mm >> CH02
- 47,7 mm >> CH03
- 50,85 mm >> CH04

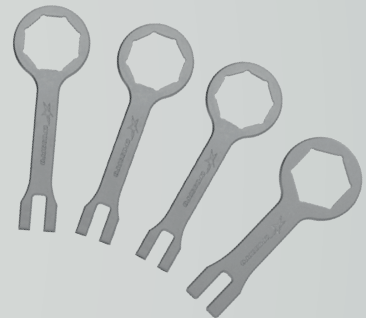

**WORKSHOP** **FORK WRENCH**

|      |                |
|------|----------------|
| CH01 | 2CP072CH010001 |
| CH02 | 2CP072CH020001 |
| CH03 | 2CP072CH030001 |
| CH04 | 2CP072CH040001 |

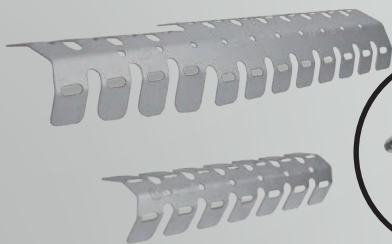

**EXHAUST** **EVO EXHAUST PROTECTION**

4 Stroke / 4 tempos 2CP07300030001  
2 Stroke / 2 tempos 2CP07300050001



**WORKSHOP** **WASTE DISPOSAL**

Universal 2CP08600010001

# HARD XTREME 2.0

## HARD XTREME 2.0 Bike lift

- »Made of extremely durable carbon steel
- »Reinforced bases for better stability
- »Replaceable non-slip rubber upper and feet
- »Optimized Lifting System
- »Electrostatic paint finish for durability
- »Innovative design.

## Cavalete HARD XTREME 2.0

- »Construído em aço carbono extremamente resistente
- »Bases reforçadas para maior estabilidade
- »Parte superior e pés em borracha antiderrapante substituíveis.
- »Sistema de elevação otimizado
- » Acabamento em pintura eletrostática para maior durabilidade
- »Design inovador.

- Weight / peso: 7,04kg
- Minimum height / altura mínima: 31cm
- Maximum height / altura máxima: 40cm
- Maximum weight / peso máximo: 210kg

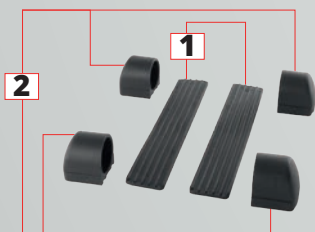

### HARD XTREME 2.0

CODE

1 Base Rubbers (2un)

2CP0820010A301

2 Foot Rubbers (4un)

2CP0820010A302





**NEW 2020**



**41**

**HARD  
XTREME 2.0**

**HARD XTREME 2.0**

CODE

|          |                |
|----------|----------------|
| ● Black  | 2CP08200120004 |
| ○ White  | 2CP08200120006 |
| ● Red    | 2CP08200120006 |
| ● Yellow | 2CP08200120008 |
| ● Green  | 2CP08200120009 |
| ● Orange | 2CP08200120010 |
| ● Blue   | 2CP08200120011 |

# GRAND PRIX HARD BIKE STAND



# 42

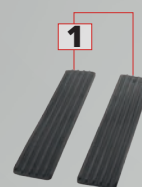

## BIKE STAND GRAND PRIX HARD

|                  |                |
|------------------|----------------|
| ○ Ice Matte      | 2CP08200110001 |
| ● Black          | 2CP08200110004 |
| ● Black Textured | 2CP08200110005 |
| ○ White          | 2CP08200110006 |
| ● Red            | 2CP08200110007 |
| ● Yellow         | 2CP08200110008 |
| ● Green          | 2CP08200110009 |
| ● Orange         | 2CP08200110010 |
| ● Blue           | 2CP08200110011 |

## PARTS SPARE PARTS

1 Black (2 un)

2CP0820010A301

### Aluminum bike stand

- »New Design in different Colors
- »More resistant
- »Hole for Oil Change
- »More Economic

### Cavaletes em alumínio

- »Novo Design em diferentes cores
- »Mais resistente
- »Orifício para mudança de óleo
- »Mais Económico

# 43

# XTREME 16 BIKE STAND



### Iron bike stand

- » Made of steel with Anti-slip rubber protection on the top
- » Anti-slip top
- » Lifting system with less effort
- » Innovative design

### Cavaletes em ferro

- » Fabricado em aço com proteção superior em borracha anti-derrapante.
- » Topos anti-derrapante.
- » Sistema de elevação com desmultiplicação de esforço.
- » Design inovador.

- » Weight / peso: 5,50kg
- » Minimum height / altura mínima: 30cm
- » Maximum height / altura máxima: 40cm
- » Maximum weight / peso máximo: 140kg

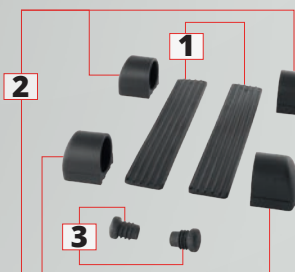

### PARTS SPARE PARTS

|                |                |
|----------------|----------------|
| 1 Black (2 un) | 2CP0820010A301 |
| 2 Black (4 un) | 2CP0820010A302 |
| 3 Black (2 un) | 2CP0820010A303 |

### BIKE STAND XTREME 16 BIKE LIFT

|          |                |
|----------|----------------|
| ● Black  | 2CP08200100005 |
| ○ White  | 2CP08200100006 |
| ● Red    | 2CP08200100007 |
| ● Yellow | 2CP08200100008 |
| ● Green  | 2CP08200100009 |
| ● Orange | 2CP08200100010 |
| ● Blue   | 2CP08200100011 |





### » Protect the important with CrossPro

Besides the ATV and UTV protections, CrossPro bets on products that allow maximizing your safety.

Combining the knowledge of these equipments with the best materials, CrossPro offers a complete range of protections and accessories that will allow you to enjoy your moto.

Developed and built by skilled professionals, this is adequate protection to a customer who knows the importance of protecting his bike.

### » Protege o mais importante com Crosspro

Além das protecções para o seu ATV e UTV, a CrossPro aposta em produtos que permitem maximizar a sua segurança.

Conjugando um vasto conhecimento sobre estes equipamentos e os melhores materiais, a CrossPro oferece uma gama completa de protecções e acessórios que lhe permitirão usufruir da melhor forma da sua moto.

Desenvolvida e construída por profissionais qualificados, esta é a protecção adequada a um cliente ciente da importância da protecção da sua moto.

# side by side

45



# YAMAHA

## YXZ 1000R/SE

### 2016



# 47

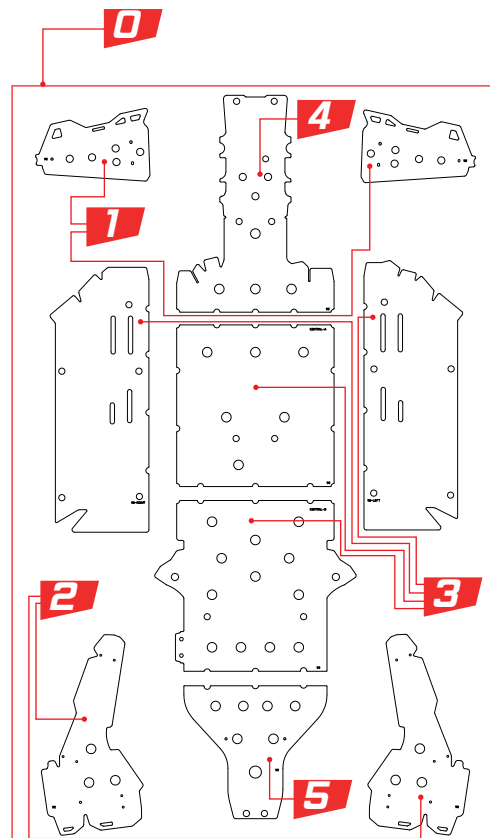

| DTC 8mm  |   | ● BLACK                 |
|----------|---|-------------------------|
| <b>0</b> | <b>Complet Kit</b><br>Kit Completo          | 2CP18700 <b>92</b> 0300 |
| <b>1</b> | <b>Front A-arms</b><br>Triângulos da frente | 2CP18800 <b>92</b> 0300 |
| <b>2</b> | <b>Rear A-arms</b><br>Triângulos de trás    | 2CP18900 <b>92</b> 0300 |
| <b>3</b> | <b>Central Carter</b><br>Carter Central     | 2CP19000 <b>92</b> 0300 |
| <b>4</b> | <b>Front Carter</b><br>Carter Frente        | 2CP19100 <b>92</b> 0300 |
| <b>5</b> | <b>Rear Carter</b><br>Carter trás           | 2CP19200 <b>92</b> 0300 |

| POLYCARBONATE |  | ● TRANSP.               |
|---------------|--|-------------------------|
| <b>12</b>     | <b>Air deflector</b><br>Defletor de ar | 2CP18500 <b>92</b> 0100 |

| ALUMINUM |   | ● ICE MATTE             | ● NEUTRAL               | ● BLACK                 | ● TEXT. BLACK           | ○ WHITE                 |
|----------|---|-------------------------|-------------------------|-------------------------|-------------------------|-------------------------|
| <b>0</b> | <b>Complet Kit</b><br>Kit Completo          | 2CP05600 <b>92</b> 0001 | 2CP05600 <b>92</b> 0003 | 2CP05600 <b>92</b> 0004 | 2CP05600 <b>92</b> 0005 | 2CP05600 <b>92</b> 0006 |
| <b>1</b> | <b>Front A-arms</b><br>Triângulos da frente | 2CP03800 <b>92</b> 0001 | 2CP03800 <b>92</b> 0003 | 2CP03800 <b>92</b> 0004 | 2CP03800 <b>92</b> 0005 | 2CP03800 <b>92</b> 0006 |
| <b>2</b> | <b>Rear A-arms</b><br>Triângulos de trás    | 2CP03900 <b>92</b> 0001 | 2CP03900 <b>92</b> 0003 | 2CP03900 <b>92</b> 0004 | 2CP03900 <b>92</b> 0005 | 2CP03900 <b>92</b> 0006 |
| <b>3</b> | <b>Central Carter</b><br>Carter Central     | 2CP06600 <b>92</b> 0001 | 2CP06600 <b>92</b> 0003 | 2CP06600 <b>92</b> 0004 | 2CP06600 <b>92</b> 0005 | 2CP06600 <b>92</b> 0006 |
| <b>4</b> | <b>Front Carter</b><br>Carter Frente        | 2CP06400 <b>92</b> 0001 | 2CP06400 <b>92</b> 0003 | 2CP06400 <b>92</b> 0004 | 2CP06400 <b>92</b> 0005 | 2CP06400 <b>92</b> 0006 |
| <b>5</b> | <b>Rear Carter</b><br>Carter Traseiro       | 2CP06500 <b>92</b> 0001 | 2CP06500 <b>92</b> 0003 | 2CP06500 <b>92</b> 0004 | 2CP06500 <b>92</b> 0005 | 2CP06500 <b>92</b> 0006 |
| <b>6</b> | <b>Front Bumper</b><br>Pára-choques Frontal | 2CP06200 <b>92</b> 0001 | -                       | 2CP06200 <b>92</b> 0004 | 2CP06200 <b>92</b> 0005 | 2CP06200 <b>92</b> 0006 |
| <b>7</b> | <b>Front Bumper</b><br>Pára-choques Frontal | 2CP0620 <b>A92</b> 0001 | -                       | 2CP0620 <b>A92</b> 0004 | 2CP0620 <b>A92</b> 0005 | 2CP0620 <b>A92</b> 0006 |
| <b>8</b> | <b>Rear Bumper</b><br>Pára-choques trás     | 2CP06300 <b>92</b> 0001 | -                       | 2CP06300 <b>92</b> 0004 | 2CP06300 <b>92</b> 0005 | 2CP06300 <b>92</b> 0006 |
| <b>9</b> | <b>Bottom side bar</b><br>Embaladeiras      | 2CP05700 <b>92</b> 0001 | -                       | 2CP05700 <b>92</b> 0004 | 2CP05700 <b>92</b> 0005 | 2CP05700 <b>92</b> 0006 |



# ARCTIC CAT

## WILDCAT 1000

### 2012-2015

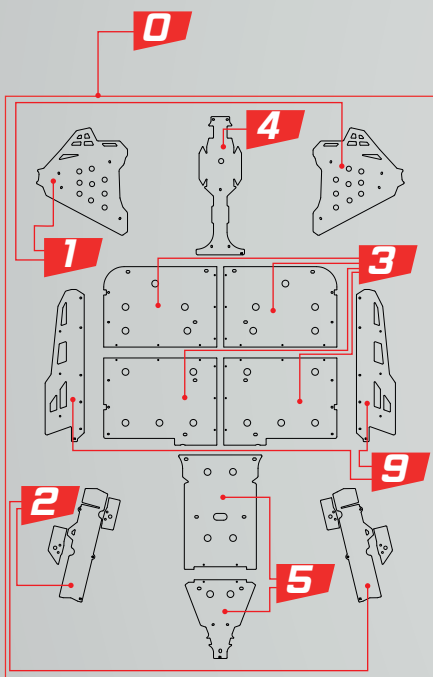

**DORS  
WILDCAT 1000**

**6** FRAME ICE MATTE

● BLACK

● BLUE

● RED

○ WHITE

● YELLOW

● ORANGE

2CP14800810301

2CP14800810401

2CP14800810501

2CP14800810601

2CP14800810701

2CP14800810801



**DORS  
WILDCAT 1000**

**6** ● FRAME BLACK

● BLACK

● BLUE

● RED

○ WHITE

● YELLOW

● ORANGE

2CP14800810305

2CP14800810405

2CP14800810505

2CP14800810605

2CP14800810705

2CP14800810805





**ALUMINUM  
WILDCAT 1000**

● ICE MATTE ● NEUTRAL ● BLACK ● TEXT. BLACK ○ WHITE

|  |                         |                         |                         |                         |                         |
|--|-------------------------|-------------------------|-------------------------|-------------------------|-------------------------|
| <b>0</b> Complet Kit<br>Kit Completo               | 2CP05600 <b>81</b> 0001 | 2CP05600 <b>81</b> 0003 | 2CP05600 <b>81</b> 0004 | 2CP05600 <b>81</b> 0005 | 2CP05600 <b>81</b> 0006 |
| <b>1</b> Front A-arms<br>Triângulos da frente      | 2CP03800 <b>81</b> 0001 | 2CP03800 <b>81</b> 0003 | 2CP03800 <b>81</b> 0004 | 2CP03800 <b>81</b> 0005 | 2CP03800 <b>81</b> 0006 |
| <b>2</b> Rear A-arms<br>Triângulos de trás         | 2CP03900 <b>81</b> 0001 | 2CP03900 <b>81</b> 0003 | 2CP03900 <b>81</b> 0004 | 2CP03900 <b>81</b> 0005 | 2CP03900 <b>81</b> 0006 |
| <b>3</b> Central Carter<br>Carter Central          | 2CP06600 <b>81</b> 0001 | 2CP06600 <b>81</b> 0003 | 2CP06600 <b>81</b> 0004 | 2CP06600 <b>81</b> 0005 | 2CP06600 <b>81</b> 0006 |
| <b>4</b> Front Carter<br>Carter Frente             | 2CP06400 <b>81</b> 0001 | 2CP06400 <b>81</b> 0003 | 2CP06400 <b>81</b> 0004 | 2CP06400 <b>81</b> 0005 | 2CP06400 <b>81</b> 0006 |
| <b>5</b> Rear Carter<br>Carter Traseiro            | 2CP06500 <b>81</b> 0001 | 2CP06500 <b>81</b> 0003 | 2CP06500 <b>81</b> 0004 | 2CP06500 <b>81</b> 0005 | 2CP06500 <b>81</b> 0006 |
| <b>6</b> Side Doors<br>Portas Laterais             | 2CP05000 <b>81</b> 0001 | -                       | 2CP05000 <b>81</b> 0004 | 2CP05000 <b>81</b> 0005 | 2CP05000 <b>81</b> 0006 |
| <b>7</b> Front Bumper<br>Pára-choques Frontal      | 2CP06200 <b>81</b> 0001 | -                       | 2CP06200 <b>81</b> 0004 | 2CP06200 <b>81</b> 0005 | 2CP06200 <b>81</b> 0006 |
| <b>8</b> Rear Bumper<br>Pára-choques trás          | 2CP06300 <b>81</b> 0001 | -                       | 2CP06300 <b>81</b> 0004 | 2CP06300 <b>81</b> 0005 | 2CP06300 <b>81</b> 0006 |
| <b>9</b> Bottom side bar<br>Embaladeiras           | 2CP05700 <b>81</b> 0001 | -                       | 2CP05700 <b>81</b> 0004 | 2CP05700 <b>81</b> 0005 | 2CP05700 <b>81</b> 0006 |
| <b>10</b> Rear extenders<br>Alargadores de trás    | 2CP05200 <b>28</b> 0001 | -                       | 2CP05200 <b>28</b> 0004 | 2CP05200 <b>28</b> 0005 | 2CP05200 <b>28</b> 0006 |
| <b>11</b> Front extenders<br>Alargadores da frente | 2CP05200 <b>28</b> 0001 | -                       | 2CP05200 <b>28</b> 0004 | 2CP05200 <b>28</b> 0005 | 2CP05200 <b>28</b> 0006 |

**DTC  
WILDCAT 1000**

● BLACK ● BLUE ● RED ○ WHITE ● YELLOW ● ORANGE

|   |                         |                         |                         |                         |                         |                         |
|---|-------------------------|-------------------------|-------------------------|-------------------------|-------------------------|-------------------------|
| <b>1</b> Front A-arms<br>Triângulos da frente | 2CP04500 <b>81</b> 0300 | 2CP04500 <b>81</b> 0400 | 2CP04500 <b>81</b> 0500 | 2CP04500 <b>81</b> 0600 | 2CP04500 <b>81</b> 0700 | 2CP04500 <b>81</b> 0800 |
| <b>3</b> Central Carter<br>Carter Central     | 2CP14300 <b>81</b> 0300 | 2CP14300 <b>81</b> 0400 | 2CP14300 <b>81</b> 0500 | 2CP14300 <b>81</b> 0600 | 2CP14300 <b>81</b> 0700 | 2CP14300 <b>81</b> 0800 |
| <b>4</b> Front Carter<br>Carter Frente        | 2CP14400 <b>81</b> 0300 | 2CP14400 <b>81</b> 0400 | 2CP14400 <b>81</b> 0500 | 2CP14400 <b>81</b> 0600 | 2CP14400 <b>81</b> 0700 | 2CP14400 <b>81</b> 0800 |
| <b>5</b> Rear Carter<br>Carter Traseiro       | 2CP14500 <b>81</b> 0300 | 2CP14500 <b>81</b> 0400 | 2CP14500 <b>81</b> 0500 | 2CP14500 <b>81</b> 0600 | 2CP14500 <b>81</b> 0700 | 2CP14500 <b>81</b> 0800 |

# CAN-AM

## COMMANDER

### XT 800/1000

### 2012-2015



#### ALUMINUM

#### XT 800/1000 12-15

● ICE MATTE ● NEUTRAL ● BLACK ● TEXT. BLACK ○ WHITE

|   |                |                |                |                |                |
|---|----------------|----------------|----------------|----------------|----------------|
| <b>0</b> Complet Kit<br>Kit Completo              | 2CP05600630001 | 2CP05600630003 | 2CP05600630004 | 2CP05600630005 | 2CP05600630006 |
| <b>1</b> Front A-arms<br>Triângulos da frente     | 2CP03800630001 | 2CP03800630003 | 2CP03800630004 | 2CP03800630005 | 2CP03800630006 |
| <b>2</b> Central Carter<br>Carter Central         | 2CP06600630001 | 2CP06600630003 | 2CP06600630004 | 2CP06600630005 | 2CP06600630006 |
| <b>3</b> Front Carter<br>Carter Frente            | 2CP06400630001 | 2CP06400630003 | 2CP06400630004 | 2CP06400630005 | 2CP06400630006 |
| <b>4</b> Rear Carter<br>Carter Central            | 2CP06500630001 | 2CP06500630003 | 2CP06500630004 | 2CP06500630005 | 2CP06500630006 |
| <b>5</b> Side Doors<br>Portas Laterais            | 2CP05000630001 | -              | 2CP05000630004 | 2CP05000630005 | 2CP05000630006 |
| <b>6</b> Front Bumper<br>Pára-choques Frontal     | 2CP06200630001 | -              | 2CP06200630004 | 2CP06200630005 | 2CP06200630006 |
| <b>7</b> Bottom side bar<br>Embaladeiras          | 2CP05700630001 | -              | 2CP05700630004 | 2CP05700630005 | 2CP05700630006 |
| <b>8</b> Rear extenders<br>Alargadores de trás    | 2CP05200420001 | -              | 2CP05200420004 | 2CP05200420005 | 2CP05200420006 |
| <b>9</b> Front extenders<br>Alargadores da frente | 2CP05200420001 | -              | 2CP05200420004 | 2CP05200420005 | 2CP05200420006 |

#### DTC

#### XT 800/1000 12-15

● BLACK ● BLUE ● RED ○ WHITE ● YELLOW ● ORANGE

|   |                |                |                |                |                |                |
|---|----------------|----------------|----------------|----------------|----------------|----------------|
| <b>0</b> Complet Kit<br>Kit Completo          | 2CP14700630300 | 2CP14700630400 | 2CP14700630500 | 2CP14700630600 | 2CP14700630700 | 2CP14700630800 |
| <b>1</b> Front A-arms<br>Triângulos da frente | 2CP04500630300 | 2CP04500630400 | 2CP04500630500 | 2CP04500630600 | 2CP04500630700 | 2CP04500630800 |
| <b>2</b> Central Carter<br>Carter Central     | 2CP14300630300 | 2CP14300630400 | 2CP14300630500 | 2CP14300630600 | 2CP14300630700 | 2CP14300630800 |
| <b>3</b> Front Carter<br>Carter Frente        | 2CP14400630300 | 2CP14400630400 | 2CP14400630500 | 2CP14400630600 | 2CP14400630700 | 2CP14400630800 |
| <b>4</b> Rear Carter<br>Carter Trás           | 2CP14500630300 | 2CP14500630400 | 2CP14500630500 | 2CP14500630600 | 2CP14500630700 | 2CP14500630800 |

# 51



**6**

**9**

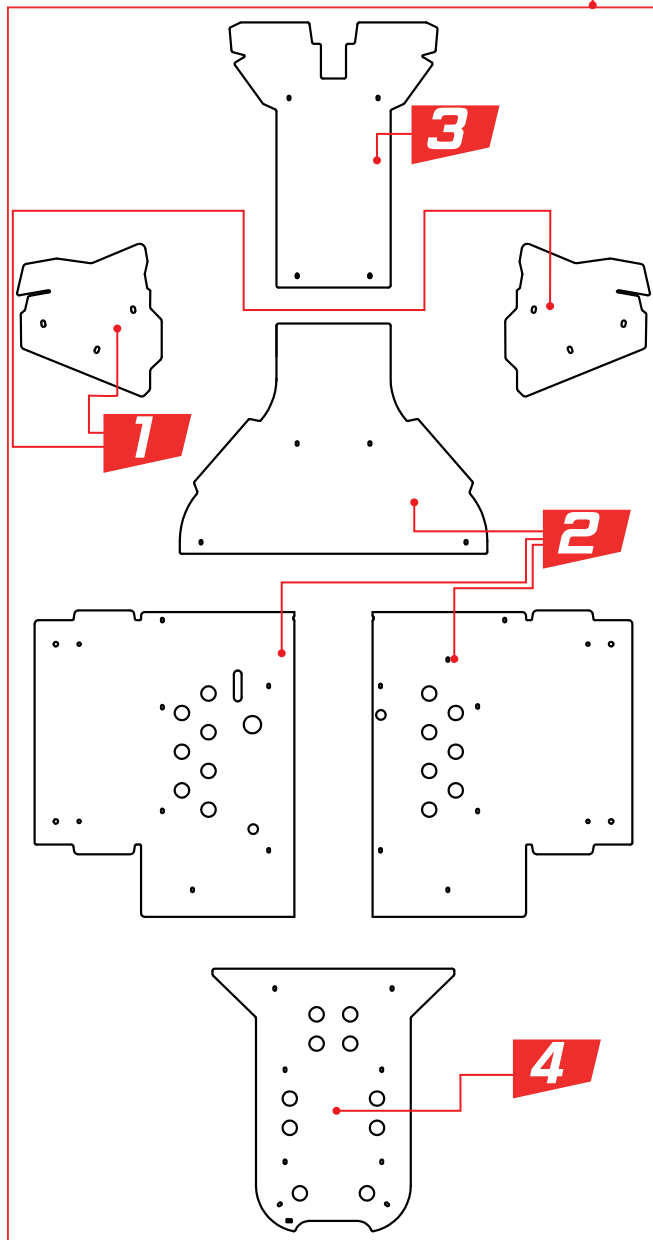

**DORS XT 800/1000 12-15**

**5** ● FRAME ICE MATTE

● BLACK

● BLUE

● RED

○ WHITE

● YELLOW

● ORANGE

2CP14800630301

2CP14800630401

2CP14800630501

2CP14800630601

2CP14800630701

2CP14800630801



**DORS**

**XT 800/1000 12-15**

**6** ● FRAME BLACK

● BLACK

● BLUE

● RED

○ WHITE

● YELLOW

● ORANGE

2CP14800630305

2CP14800630405

2CP14800630505

2CP14800630605

2CP14800630705

2CP14800630805

# CAN-AM MAVERICK 1000 2013



**DORS  
MAVERICK 1000**

**6** FRAME ICE MATTE

● BLACK

● BLUE

● RED

○ WHITE

● YELLOW

● ORANGE

2CP14800880301

2CP14800880401

2CP14800880501

2CP14800880601

2CP14800880701

2CP14800880801



**DORS  
MAVERICK 1000**

**6** ● FRAME BLACK

● BLACK

● BLUE

● RED

○ WHITE

● YELLOW

● ORANGE

2CP14800880305

2CP14800880405

2CP14800880505

2CP14800880605

2CP14800880705

2CP14800880805

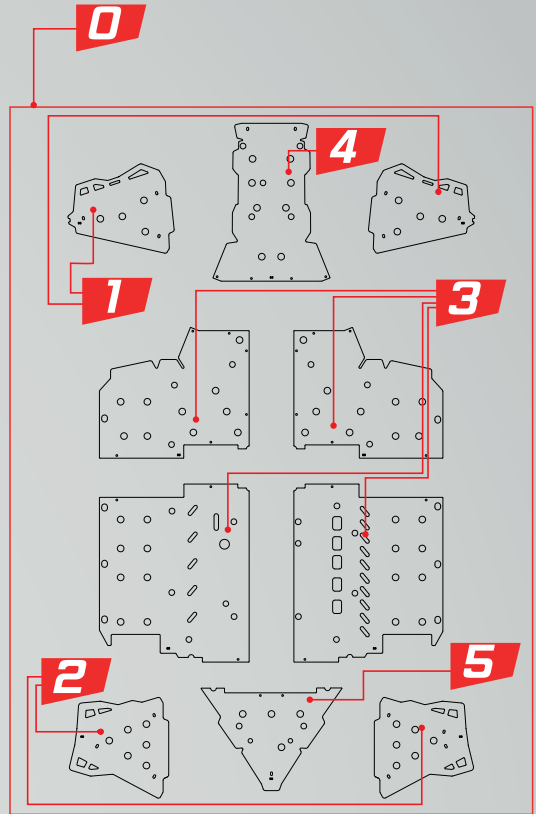

**ALUMINUM  
MAVERICK 1000**

● ICE MATTE ● NEUTRAL ● BLACK ● TEXT. BLACK ○ WHITE

|  |                |                |                |                |                |
|--|----------------|----------------|----------------|----------------|----------------|
| <b>0</b> Complet Kit<br>Kit Completo               | 2CP05600880001 | 2CP05600880003 | 2CP05600880004 | 2CP05600880005 | 2CP05600880006 |
| <b>1</b> Front A-arms<br>Triângulos da frente      | 2CP03800880001 | 2CP03800880003 | 2CP03800880004 | 2CP03800880005 | 2CP03800880006 |
| <b>2</b> Rear A-arms<br>Triângulos de trás         | 2CP03900880001 | 2CP03900880003 | 2CP03900880004 | 2CP03900880005 | 2CP03900880006 |
| <b>3</b> Central Carter<br>Carter Central          | 2CP06600880001 | 2CP06600880003 | 2CP06600880004 | 2CP06600880005 | 2CP06600880006 |
| <b>4</b> Front Carter<br>Carter Frente             | 2CP06400880001 | 2CP06400880003 | 2CP06400880004 | 2CP06400880005 | 2CP06400880006 |
| <b>5</b> Rear Carter<br>Carter Traseiro            | 2CP06500880001 | 2CP06500880003 | 2CP06500880004 | 2CP06500880005 | 2CP06500880006 |
| <b>6</b> Side Doors<br>Portas Laterais             | 2CP05000880001 | -              | 2CP05000880004 | 2CP05000880005 | 2CP05000880006 |
| <b>7</b> Front Bumper<br>Pára-choques Frontal      | 2CP06200880001 | -              | 2CP06200880004 | 2CP06200880005 | 2CP06200880006 |
| <b>8</b> Rear Bumper<br>Pára-choques trás          | 2CP06300880001 | -              | 2CP06300880004 | 2CP06300880005 | 2CP06300880006 |
| <b>9</b> Bottom side bar<br>Embaladeiras           | 2CP05700880001 | -              | 2CP05700880004 | 2CP05700880005 | 2CP05700880006 |
| <b>10</b> Rear extenders<br>Alargadores de trás    | 2CP05200420001 | -              | 2CP05200420004 | 2CP05200420005 | 2CP05200420006 |
| <b>11</b> Front extenders<br>Alargadores da frente | 2CP05200420001 | -              | 2CP05200420004 | 2CP05200420005 | 2CP05200420006 |
| <b>12</b> Roof<br>Tejadilho                        | -              | 2CP17500880003 | 2CP17500880004 | 2CP17500880005 | 2CP17500880006 |

**DTC  
MAVERICK 1000**

● BLACK ● BLUE ● RED ○ WHITE ● YELLOW ● ORANGE

|   |                |                |                |                |                |                |
|---|----------------|----------------|----------------|----------------|----------------|----------------|
| <b>0</b> Complet Kit<br>Kit Completo          | 2CP14700880300 | 2CP14700880400 | 2CP14700880500 | 2CP14700880600 | 2CP14700880700 | 2CP14700880800 |
| <b>1</b> Front A-arms<br>Triângulos da frente | 2CP04500880300 | 2CP04500880400 | 2CP04500880500 | 2CP04500880600 | 2CP04500880700 | 2CP04500880800 |
| <b>2</b> Rear A-arms<br>Triângulos da trás    | 2CP11600880300 | 2CP11600880400 | 2CP11600880500 | 2CP11600880600 | 2CP11600880700 | 2CP11600880800 |
| <b>3</b> Central Carter<br>Carter Central     | 2CP14300880300 | 2CP14300880400 | 2CP14300880500 | 2CP14300880600 | 2CP14300880700 | 2CP14300880800 |
| <b>4</b> Front Carter<br>Carter Frente        | 2CP14400880300 | 2CP14400880400 | 2CP14400880500 | 2CP14400880600 | 2CP14400880700 | 2CP14400880800 |
| <b>5</b> Rear Carter<br>Carter Traseiro       | 2CP14500880300 | 2CP14500880400 | 2CP14500880500 | 2CP14500880600 | 2CP14500880700 | 2CP14500880800 |
| <b>T</b> Roof 8mm<br>Tejadilho 8mm            | 2CP17400880300 | -              | -              | -              | -              | -              |

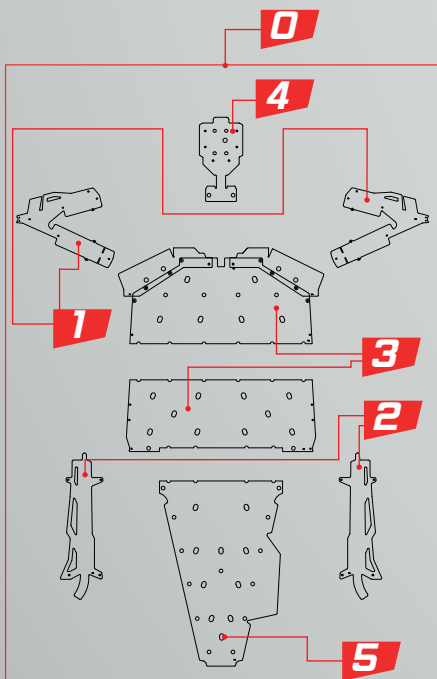

| DTC                |  | ● BLACK        |
|--------------------|--|----------------|
| <b>MAVERICK X3</b> |  |                |
|                    | Rear A-arms (6mm)                      |                |
| <b>2</b>           | Triângulos de trás<br>*not for XD S    | 2CP11600940300 |
| <b>3</b>           | Central Carter (8mm)<br>Carter Central | 2CP19000940300 |
| <b>4</b>           | Front Carter (6mm)<br>Carter Frente    | 2CP14400940300 |
| <b>5</b>           | Rear Carter (8mm)<br>Carter trás       | 2CP19200940300 |

| ALUMINUM           |  | ● ICE MATTE    | ● NEUTRAL      | ● BLACK        | ● TEXT. BLACK  | ○ WHITE        |
|--------------------|--|----------------|----------------|----------------|----------------|----------------|
| <b>MAVERICK X3</b> |  |                |                |                |                |                |
| <b>0</b>           | Complet Kit *not for XD S<br>Kit Completo              | 2CP05600940001 | 2CP05600940003 | 2CP05600940004 | 2CP05600940005 | 2CP05600940006 |
| <b>1</b>           | Front A-arms *not for XD S<br>Triângulos da frente     | 2CP03800940001 | 2CP03800940003 | 2CP03800940004 | 2CP03800940005 | 2CP03800940006 |
| <b>2</b>           | Rear A-arms *not for XD S<br>Triângulos de trás        | 2CP03900940001 | 2CP03900940003 | 2CP03900940004 | 2CP03900940005 | 2CP03900940006 |
| <b>3</b>           | Central Carter<br>Carter Central                       | 2CP06600940001 | 2CP06600940003 | 2CP06600940004 | 2CP06600940005 | 2CP06600940006 |
| <b>4</b>           | Front Carter<br>Carter Frente                          | 2CP06400940001 | 2CP06400940003 | 2CP06400940004 | 2CP06400940005 | 2CP06400940006 |
| <b>5</b>           | Rear Carter<br>Carter Traseiro                         | 2CP06500940001 | 2CP06500940003 | 2CP06500940004 | 2CP06500940005 | 2CP06500940006 |
| <b>6</b>           | Side Doors<br>Portas Laterais                          | 2CP05000940001 | -              | 2CP05000940004 | 2CP05000940005 | 2CP05000940006 |
| <b>*6</b>          | Cover for original Doors<br>Capa p/ Portas (originais) | 2CP0500A940001 | -              | 2CP0500A940004 | 2CP0500A940005 | 2CP0500A940006 |
| <b>7</b>           | Front Bumper<br>Pára-choques Frontal                   | 2CP06200940001 | -              | 2CP06200940004 | 2CP06200940005 | 2CP06200940006 |
| <b>9</b>           | Bottom side bar<br>Embaladeiras                        | 2CP05700940001 | -              | 2CP05700940004 | 2CP05700940005 | 2CP05700940006 |

# CAN-AM

## MAVERICK X3

TURBO/X DS\* / X RC/X RS

# 2017-2019



7

7

### // TRAILER HITCH



Trailer Hitch (Support only) 2CP19400010004  
Trailer Ball (Ball only) RP23400100



#### DORS MAVERICK X3

6 FRAME ICE MATTE    2CP14800940301    2CP14800940401    2CP14800940501    2CP14800940601    2CP14800940701    2CP14800940801



#### DORS MAVERICK X3

6 FRAME BLACK    2CP14800940305    2CP14800940405    2CP14800940505    2CP14800940605    2CP14800940705    2CP14800940805

# POLARIS

## RZR

### 800/800s



#### ALUMINUM

##### RZR 800 08-14

● ICE MATTE ● NEUTRAL ● BLACK ● TEXT. BLACK ○ WHITE

|  |                |                |                |                |                |
|--|----------------|----------------|----------------|----------------|----------------|
| <b>0</b> Complet Kit<br>Kit Completo               | 2CP05600450001 | 2CP05600450003 | 2CP05600450004 | 2CP05600450005 | 2CP05600450006 |
| <b>1</b> Front A-arms<br>Triângulos da frente      | 2CP03800450001 | 2CP03800450003 | 2CP03800450004 | 2CP03800450005 | 2CP03800450006 |
| <b>2</b> Rear A-arms<br>Triângulos de trás         | 2CP03900450001 | 2CP03900450003 | 2CP03900450004 | 2CP03900450005 | 2CP03900450006 |
| <b>3</b> Central Carter<br>Carter Central          | 2CP06600450001 | 2CP06600450003 | 2CP06600450004 | 2CP06600450005 | 2CP06600450006 |
| <b>4</b> Front Carter<br>Carter Frente             | 2CP06400450001 | 2CP06400450003 | 2CP06400450004 | 2CP06400450005 | 2CP06400450006 |
| <b>5</b> Rear Carter<br>Carter Traseiro            | 2CP06500450001 | 2CP06500450003 | 2CP06500450004 | 2CP06500450005 | 2CP06500450006 |
| <b>6</b> Side Doors<br>Portas Laterais             | 2CP05000450001 | -              | 2CP05000450004 | 2CP05000450005 | 2CP05000450006 |
| <b>7</b> Front Bumper<br>Pára-choques Frontal      | 2CP06200450001 | -              | 2CP06200450004 | 2CP06200450005 | 2CP06200450006 |
| <b>8</b> Rear Bumper<br>Pára-choques trás          | 2CP06300450001 | -              | 2CP06300450004 | 2CP06300450005 | 2CP06300450006 |
| <b>9</b> Bottom side bar<br>Embaladeiras           | 2CP05700450001 | -              | 2CP05700450004 | 2CP05700450005 | 2CP05700450006 |
| <b>10</b> Rear extenders<br>Alargadores de trás    | 2CP05200320001 | -              | 2CP05200320004 | 2CP05200320005 | 2CP05200320006 |
| <b>11</b> Front extenders<br>Alargadores da frente | 2CP05200320001 | -              | 2CP05200320004 | 2CP05200320005 | 2CP05200320006 |

#### ALUMINUM

##### RZR 800s 09-14

● ICE MATTE ● NEUTRAL ● BLACK ● TEXT. BLACK ○ WHITE

|  |                |                |                |                |                |
|--|----------------|----------------|----------------|----------------|----------------|
| <b>0</b> Complet Kit<br>Kit Completo               | 2CP05600660001 | 2CP05600660003 | 2CP05600660004 | 2CP05600660005 | 2CP05600660006 |
| <b>1</b> Front A-arms<br>Triângulos da frente      | 2CP03800660001 | 2CP03800660003 | 2CP03800660004 | 2CP03800660005 | 2CP03800660006 |
| <b>2</b> Rear A-arms<br>Triângulos de trás         | 2CP03900660001 | 2CP03900660003 | 2CP03900660004 | 2CP03900660005 | 2CP03900660006 |
| <b>3</b> Central Carter<br>Carter Central          | 2CP06600450001 | 2CP06600450003 | 2CP06600450004 | 2CP06600450005 | 2CP06600450006 |
| <b>4</b> Front Carter<br>Carter Frente             | 2CP06400450001 | 2CP06400450003 | 2CP06400450004 | 2CP06400450005 | 2CP06400450006 |
| <b>5</b> Rear Carter<br>Carter Traseiro            | 2CP06500660001 | 2CP06500660003 | 2CP06500660004 | 2CP06500660005 | 2CP06500660006 |
| <b>6</b> Side Doors<br>Portas Laterais             | 2CP05000450001 | -              | 2CP05000450004 | 2CP05000450005 | 2CP05000450006 |
| <b>7</b> Front Bumper<br>Pára-choques Frontal      | 2CP06200450001 | -              | 2CP06200450004 | 2CP06200450005 | 2CP06200450006 |
| <b>8</b> Rear Bumper<br>Pára-choques trás          | 2CP06300450001 | -              | 2CP06300450004 | 2CP06300450005 | 2CP06300450006 |
| <b>9</b> Bottom side bar<br>Embaladeiras           | 2CP05700660001 | -              | 2CP05700660004 | 2CP05700660005 | 2CP05700660006 |
| <b>10</b> Rear extenders<br>Alargadores de trás    | 2CP05200320001 | -              | 2CP05200320004 | 2CP05200320005 | 2CP05200320006 |
| <b>11</b> Front extenders<br>Alargadores da frente | 2CP05200320001 | -              | 2CP05200320004 | 2CP05200320005 | 2CP05200320006 |

#### RZR 800

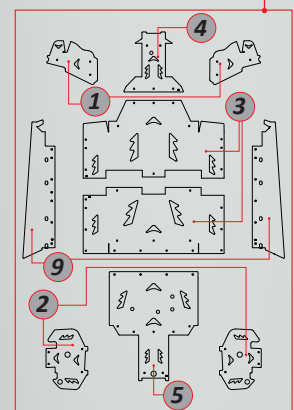

#### RZR 800s

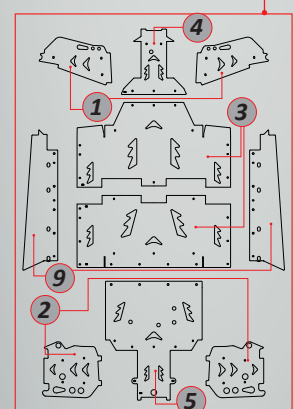



# 57



| DORS<br>RZR 800 08-14      | ● BLACK        | ● BLUE         | ● RED          | ○ WHITE        | ● YELLOW       | ● ORANGE       |
|----------------------------|----------------|----------------|----------------|----------------|----------------|----------------|
| <b>5</b> ● FRAME ICE MATTE | 2CP14800450301 | 2CP14800450401 | 2CP14800450501 | 2CP14800450601 | 2CP14800450701 | 2CP14800450801 |
| DORS<br>RZR 800s 09-14     | ● BLACK        | ● BLUE         | ● RED          | ○ WHITE        | ● YELLOW       | ● ORANGE       |
| <b>5</b> ● FRAME ICE MATTE | 2CP14800450301 | 2CP14800450401 | 2CP14800450501 | 2CP14800450601 | 2CP14800450701 | 2CP14800450801 |



| DORS<br>RZR 800 08-14  | ● BLACK        | ● BLUE         | ● RED          | ○ WHITE        | ● YELLOW       | ● ORANGE       |
|------------------------|----------------|----------------|----------------|----------------|----------------|----------------|
| <b>5</b> ● FRAME BLACK | 2CP14800450305 | 2CP14800450405 | 2CP14800450505 | 2CP14800450605 | 2CP14800450705 | 2CP14800450805 |
| DORS<br>RZR 800s 09-14 | ● BLACK        | ● BLUE         | ● RED          | ○ WHITE        | ● YELLOW       | ● ORANGE       |
| <b>5</b> ● FRAME BLACK | 2CP14800450305 | 2CP14800450405 | 2CP14800450505 | 2CP14800450605 | 2CP14800450705 | 2CP14800450805 |



## » RZR 800

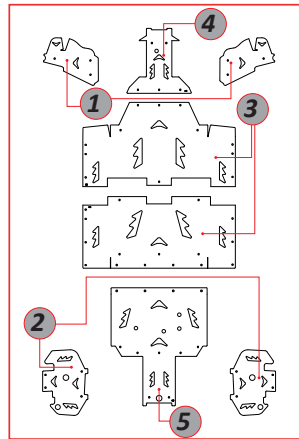

## » RZR 800 S

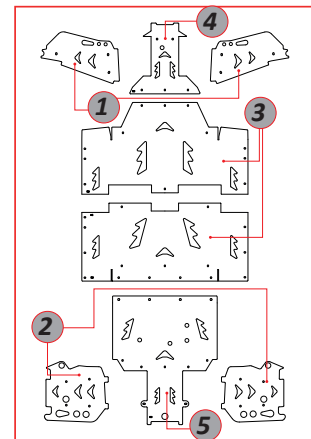

| DTC<br>RZR 800 08-14                          | ● BLACK        | ● BLUE         | ● RED          | ○ WHITE        | ● YELLOW       | ● ORANGE       |
|---|----------------|----------------|----------------|----------------|----------------|----------------|
| <b>1</b> Front A-arms<br>Triângulos da frente | 2CP04500450300 | 2CP04500450400 | 2CP04500450500 | 2CP04500450600 | 2CP04500450700 | 2CP04500450800 |
| <b>2</b> Rear A-arms<br>Triângulos de trás    | 2CP11600450300 | 2CP11600450400 | 2CP11600450500 | 2CP11600450600 | 2CP11600450700 | 2CP11600450800 |
| <b>3</b> Central Carter<br>Carter Central     | 2CP14300450300 | 2CP14300450400 | 2CP14300450500 | 2CP14300450600 | 2CP14300450700 | 2CP14300450800 |
| <b>4</b> Front Carter<br>Carter Frente        | 2CP14400450300 | 2CP14400450400 | 2CP14400450500 | 2CP14400450600 | 2CP14400450700 | 2CP14400450800 |
| <b>5</b> Rear Carter<br>Carter Traseiro       | 2CP14500450300 | 2CP14500450400 | 2CP14500450500 | 2CP14500450600 | 2CP14500450700 | 2CP14500450800 |

| DTC<br>RZR 800s 09-14                         | ● BLACK        | ● BLUE         | ● RED          | ○ WHITE        | ● YELLOW       | ● ORANGE       |
|---|----------------|----------------|----------------|----------------|----------------|----------------|
| <b>1</b> Front A-arms<br>Triângulos da frente | 2CP04500660300 | 2CP04500660400 | 2CP04500660500 | 2CP04500660600 | 2CP04500660700 | 2CP04500660800 |
| <b>2</b> Rear A-arms<br>Triângulos de trás    | 2CP11600660300 | 2CP11600660400 | 2CP11600660500 | 2CP11600660600 | 2CP11600660700 | 2CP11600660800 |
| <b>3</b> Central Carter<br>Carter Central     | 2CP14300450300 | 2CP14300450400 | 2CP14300450500 | 2CP14300450600 | 2CP14300450700 | 2CP14300450800 |
| <b>4</b> Front Carter<br>Carter Frente        | 2CP14400450300 | 2CP14400450400 | 2CP14400450500 | 2CP14400450600 | 2CP14400450700 | 2CP14400450800 |
| <b>5</b> Rear Carter<br>Carter Traseiro       | 2CP14500660300 | 2CP14500660400 | 2CP14500660500 | 2CP14500660600 | 2CP14500660700 | 2CP14500660800 |

# POLARIS

## RZR 900

### 2011-2014



**DORS**  
RZR 900 11-14

**6** ● FRAME ICE MATTE

|                |                |                |                |                |                |
|----------------|----------------|----------------|----------------|----------------|----------------|
|                |                |                |                |                |                |
| ● BLACK        | ● BLUE         | ● RED          | ○ WHITE        | ● YELLOW       | ● ORANGE       |
| 2CP14800780301 | 2CP14800780401 | 2CP14800780501 | 2CP14800780601 | 2CP14800780701 | 2CP14800780801 |



**DORS**  
RZR 900 11-14

**5** ● FRAME BLACK

|                |                |                |                |                |                |
|----------------|----------------|----------------|----------------|----------------|----------------|
|                |                |                |                |                |                |
| ● BLACK        | ● BLUE         | ● RED          | ○ WHITE        | ● YELLOW       | ● ORANGE       |
| 2CP14800780305 | 2CP14800780405 | 2CP14800780505 | 2CP14800780605 | 2CP14800780705 | 2CP14800780805 |



# 59



7

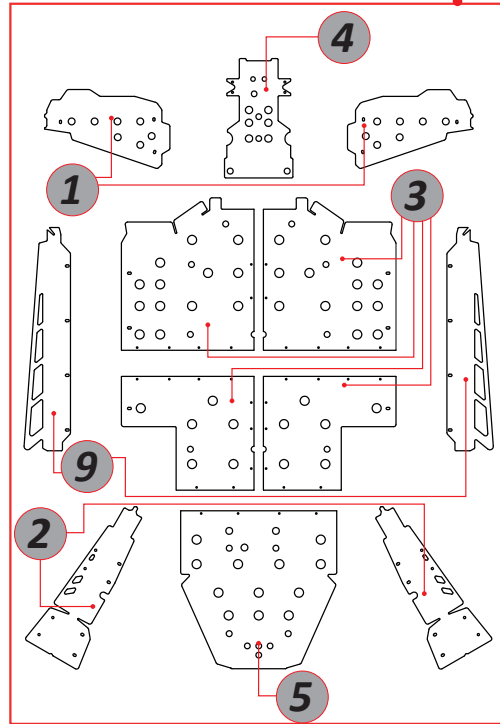

11

### ALUMINUM

#### RZR 900 11-14

● ICE MATTE ● NEUTRAL ● BLACK ● TEXT. BLACK ○ WHITE

|   |                |                |                |                |                |
|---|----------------|----------------|----------------|----------------|----------------|
| <b>0</b> <b>Complet Kit</b><br>Kit Completo               | 2CP05600780001 | 2CP05600780003 | 2CP05600780004 | 2CP05600780005 | 2CP05600780006 |
| <b>1</b> <b>Front A-arms</b><br>Triângulos da frente      | 2CP03800780001 | 2CP03800780003 | 2CP03800780004 | 2CP03800780005 | 2CP03800780006 |
| <b>2</b> <b>Rear A-arms</b><br>Triângulos de trás         | 2CP03900780001 | 2CP03900780003 | 2CP03900780004 | 2CP03900780005 | 2CP03900780006 |
| <b>3</b> <b>Central Carter</b><br>Carter Central          | 2CP06600780001 | 2CP06600780003 | 2CP06600780004 | 2CP06600780005 | 2CP06600780006 |
| <b>4</b> <b>Front Carter</b><br>Carter Frente             | 2CP06400780001 | 2CP06400780003 | 2CP06400780004 | 2CP06400780005 | 2CP06400780006 |
| <b>5</b> <b>Rear Carter</b><br>Carter Traseiro            | 2CP06500780001 | 2CP06500780003 | 2CP06500780004 | 2CP06500780005 | 2CP06500780006 |
| <b>6</b> <b>Side Doors</b><br>Portas Laterais             | 2CP05000780001 | -              | 2CP05000780004 | 2CP05000780005 | 2CP05000780006 |
| <b>7</b> <b>Front Bumper</b><br>Pára-choques Frontal      | 2CP06200780001 | -              | 2CP06200780004 | 2CP06200780005 | 2CP06200780006 |
| <b>8</b> <b>Rear Bumper</b><br>Pára-choques trás          | 2CP06300780001 | -              | 2CP06300780004 | 2CP06300780005 | 2CP06300780006 |
| <b>9</b> <b>Bottom side bar</b><br>Embaladeiras           | 2CP05700780001 | -              | 2CP05700780004 | 2CP05700780005 | 2CP05700780006 |
| <b>10</b> <b>Rear extenders</b><br>Alargadores de trás    | 2CP05200320001 | -              | 2CP05200320004 | 2CP05200320005 | 2CP05200320006 |
| <b>11</b> <b>Front extenders</b><br>Alargadores da frente | 2CP05200320001 | -              | 2CP05200320004 | 2CP05200320005 | 2CP05200320006 |

### DTC

#### RZR 900 11-14

● BLACK ● BLUE ● RED ○ WHITE ● YELLOW ● ORANGE

|  |                |                |                |                |                |                |
|--|----------------|----------------|----------------|----------------|----------------|----------------|
| <b>1</b> <b>Front A-arms</b><br>Triângulos da frente | 2CP04500780300 | 2CP04500780400 | 2CP04500780500 | 2CP04500780600 | 2CP04500780700 | 2CP04500780800 |
| <b>2</b> <b>Rear A-arms</b><br>Triângulos de trás    | 2CP11600780300 | 2CP11600780400 | 2CP11600780500 | 2CP11600780600 | 2CP11600780700 | 2CP11600780800 |
| <b>3</b> <b>Central Carter</b><br>Carter Central     | 2CP14300780300 | 2CP14300780400 | 2CP14300780500 | 2CP14300780600 | 2CP14300780700 | 2CP14300780800 |
| <b>4</b> <b>Front Carter</b><br>Carter Frente        | 2CP14400780300 | 2CP14400780400 | 2CP14400780500 | 2CP14400780600 | 2CP14400780700 | 2CP14400780800 |
| <b>5</b> <b>Rear Carter</b><br>Carter Traseiro       | 2CP14500780300 | 2CP14500780400 | 2CP14500780500 | 2CP14500780600 | 2CP14500780700 | 2CP14500780800 |



# POLARIS

## RZR 900s

### 2015



**DORS**  
**RZR 900s 2015**

**6** • FRAME ICE MATTE

- BLACK  
2CP14800890301
- BLUE  
2CP14800890401
- RED  
2CP14800890501
- WHITE  
2CP14800890601
- YELLOW  
2CP14800890701
- ORANGE  
2CP14800890801



**DORS**  
**RZR 900s 2015**

**6** • FRAME BLACK

- BLACK  
2CP14800890305
- BLUE  
2CP14800890405
- RED  
2CP14800890505
- WHITE  
2CP14800890605
- YELLOW  
2CP14800890705
- ORANGE  
2CP14800890805

# 61

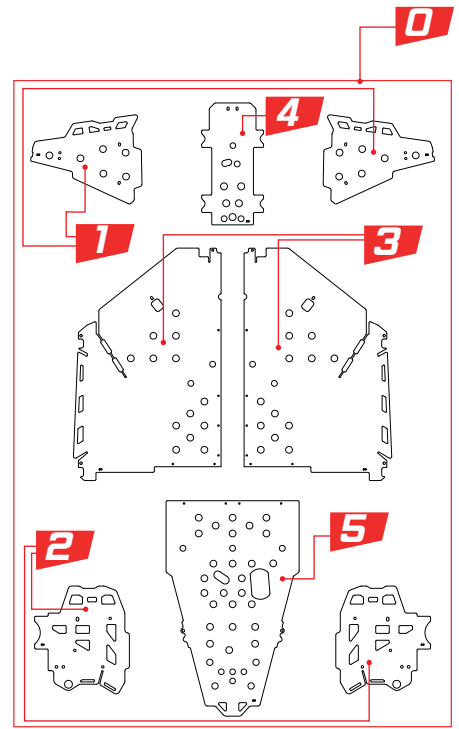

## ALUMINUM RZR 900s 2015

● ICE MATTE ● NEUTRAL ● BLACK ● TEXT. BLACK ○ WHITE

|   |                         |                         |                         |                         |                         |
|---|-------------------------|-------------------------|-------------------------|-------------------------|-------------------------|
| <b>0</b> <b>Complet Kit</b><br>Kit Completo               | 2CP05600 <b>89</b> 0001 | 2CP05600 <b>89</b> 0003 | 2CP05600 <b>89</b> 0004 | 2CP05600 <b>89</b> 0005 | 2CP05600 <b>89</b> 0006 |
| <b>1</b> <b>Front A-arms</b><br>Triângulos da frente      | 2CP03800 <b>89</b> 0001 | 2CP03800 <b>89</b> 0003 | 2CP03800 <b>89</b> 0004 | 2CP03800 <b>89</b> 0005 | 2CP03800 <b>89</b> 0006 |
| <b>2</b> <b>Rear A-arms</b><br>Triângulos de trás         | 2CP03900 <b>89</b> 0001 | 2CP03900 <b>89</b> 0003 | 2CP03900 <b>89</b> 0004 | 2CP03900 <b>89</b> 0005 | 2CP03900 <b>89</b> 0006 |
| <b>3</b> <b>Central Carter</b><br>Carter Central          | 2CP06600 <b>89</b> 0001 | 2CP06600 <b>89</b> 0003 | 2CP06600 <b>89</b> 0004 | 2CP06600 <b>89</b> 0005 | 2CP06600 <b>89</b> 0006 |
| <b>4</b> <b>Front Carter</b><br>Carter Frente             | 2CP06400 <b>89</b> 0001 | 2CP06400 <b>89</b> 0003 | 2CP06400 <b>89</b> 0004 | 2CP06400 <b>89</b> 0005 | 2CP06400 <b>89</b> 0006 |
| <b>5</b> <b>Rear Carter</b><br>Carter Traseiro            | 2CP06500 <b>89</b> 0001 | 2CP06500 <b>89</b> 0003 | 2CP06500 <b>89</b> 0004 | 2CP06500 <b>89</b> 0005 | 2CP06500 <b>89</b> 0006 |
| <b>6</b> <b>Side Doors</b><br>Portas Laterais             | 2CP05000 <b>89</b> 0001 | -                       | 2CP05000 <b>89</b> 0004 | 2CP05000 <b>89</b> 0005 | 2CP05000 <b>89</b> 0006 |
| <b>7</b> <b>Front Bumper</b><br>Para-choques Frontal      | 2CP06200 <b>87</b> 0001 | -                       | 2CP06200 <b>87</b> 0004 | 2CP06200 <b>87</b> 0005 | 2CP06200 <b>87</b> 0006 |
| <b>8</b> <b>Rear Bumper</b><br>Para-choques trás          | 2CP06300 <b>89</b> 0001 | -                       | 2CP06300 <b>89</b> 0004 | 2CP06300 <b>89</b> 0005 | 2CP06300 <b>89</b> 0006 |
| <b>9</b> <b>Bottom side bar</b><br>Embaladeiras           | 2CP05700 <b>87</b> 0001 | -                       | 2CP05700 <b>87</b> 0004 | 2CP05700 <b>87</b> 0005 | 2CP05700 <b>87</b> 0006 |
| <b>10</b> <b>Rear extenders</b><br>Alargadores de trás    | 2CP05200 <b>46</b> 0001 | -                       | 2CP05200 <b>46</b> 0004 | 2CP05200 <b>46</b> 0005 | 2CP05200 <b>46</b> 0006 |
| <b>11</b> <b>Front extenders</b><br>Alargadores da frente | 2CP05200 <b>46</b> 0001 | -                       | 2CP05200 <b>46</b> 0004 | 2CP05200 <b>46</b> 0005 | 2CP05200 <b>46</b> 0006 |
| <b>12</b> <b>Roof</b><br>Tejadilho                        | -                       | 2CP17500 <b>87</b> 0003 | 2CP17500 <b>87</b> 0004 | 2CP17500 <b>87</b> 0005 | 2CP17500 <b>87</b> 0006 |

## DTC

### RZR 900s 2015

● BLACK ● BLUE ● RED ○ WHITE ● YELLOW ● ORANGE

|  |                         |                         |                         |                         |                         |                         |
|--|-------------------------|-------------------------|-------------------------|-------------------------|-------------------------|-------------------------|
| <b>0</b> <b>Complet Kit</b><br>Kit Completo          | 2CP14700 <b>89</b> 0300 | 2CP14700 <b>89</b> 0400 | 2CP14700 <b>89</b> 0500 | 2CP14700 <b>89</b> 0600 | 2CP14700 <b>89</b> 0700 | 2CP14700 <b>89</b> 0800 |
| <b>1</b> <b>Front A-arms</b><br>Triângulos da frente | 2CP04500 <b>89</b> 0300 | 2CP04500 <b>89</b> 0400 | 2CP04500 <b>89</b> 0500 | 2CP04500 <b>89</b> 0600 | 2CP04500 <b>89</b> 0700 | 2CP04500 <b>89</b> 0800 |
| <b>2</b> <b>Rear A-arms</b><br>Triângulos de trás    | 2CP11600 <b>89</b> 0300 | 2CP11600 <b>89</b> 0400 | 2CP11600 <b>89</b> 0500 | 2CP11600 <b>89</b> 0600 | 2CP11600 <b>89</b> 0700 | 2CP11600 <b>89</b> 0800 |
| <b>3</b> <b>Central Carter</b><br>Carter Central     | 2CP14300 <b>89</b> 0300 | 2CP14300 <b>89</b> 0400 | 2CP14300 <b>89</b> 0500 | 2CP14300 <b>89</b> 0600 | 2CP14300 <b>89</b> 0700 | 2CP14300 <b>89</b> 0800 |
| <b>4</b> <b>Front Carter</b><br>Carter Frente        | 2CP14400 <b>89</b> 0300 | 2CP14400 <b>89</b> 0400 | 2CP14400 <b>89</b> 0500 | 2CP14400 <b>89</b> 0600 | 2CP14400 <b>89</b> 0700 | 2CP14400 <b>89</b> 0800 |
| <b>5</b> <b>Rear Carter</b><br>Carter Trás           | 2CP14500 <b>89</b> 0300 | 2CP14500 <b>89</b> 0400 | 2CP14500 <b>89</b> 0500 | 2CP14500 <b>89</b> 0600 | 2CP14500 <b>89</b> 0700 | 2CP14500 <b>89</b> 0800 |
| <b>7</b> <b>Roof 6mm</b><br>Tejadilho 6mm            | 2CP17300 <b>87</b> 0300 | -                       | -                       | -                       | -                       | -                       |

# POLARIS

## RZR 1000

### 2014-2015



**DORS**  
**RZR 1000 14-15**

**6**

FRAME ICE MATTE

● BLACK

● BLUE

● RED

○ WHITE

● YELLOW

● ORANGE

2CP14800870301

2CP14800870401

2CP14800870501

2CP14800870601

2CP14800870701

2CP14800870801



**DORS**  
**RZR 1000 14-15**

**6**

● FRAME BLACK

● BLACK

● BLUE

● RED

○ WHITE

● YELLOW

● ORANGE

2CP14800870305

2CP14800870405

2CP14800870505

2CP14800870605

2CP14800870705

2CP14800870805

# 63

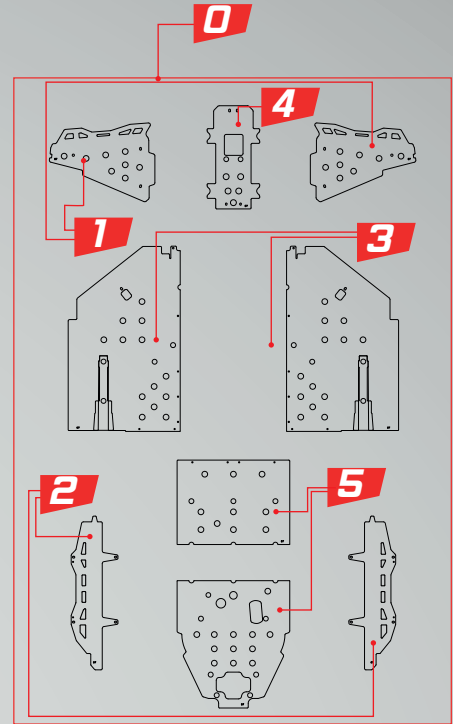

## ALUMINUM

### RZR 1000 14-15

● ICE MATTE ● NEUTRAL ● BLACK ● TEXT. BLACK ○ WHITE

|  |                |                |                |                |                |
|--|----------------|----------------|----------------|----------------|----------------|
| <b>0</b> Complet Kit<br>Kit Completo               | 2CP05600870001 | 2CP05600870003 | 2CP05600870004 | 2CP05600870005 | 2CP05600870006 |
| <b>1</b> Front A-arms<br>Triângulos da frente      | 2CP03800870001 | 2CP03800870003 | 2CP03800870004 | 2CP03800870005 | 2CP03800870006 |
| <b>2</b> Rear A-arms<br>Triângulos de trás         | 2CP03900870001 | 2CP03900870003 | 2CP03900870004 | 2CP03900870005 | 2CP03900870006 |
| <b>3</b> Central Carter<br>Carter Central          | 2CP06600870001 | 2CP06600870003 | 2CP06600870004 | 2CP06600870005 | 2CP06600870006 |
| <b>4</b> Front Carter<br>Carter Frente             | 2CP06400870001 | 2CP06400870003 | 2CP06400870004 | 2CP06400870005 | 2CP06400870006 |
| <b>5</b> Rear Carter<br>Carter Traseiro            | 2CP06500870001 | 2CP06500870003 | 2CP06500870004 | 2CP06500870005 | 2CP06500870006 |
| <b>6</b> Side Doors<br>Portas Laterais             | 2CP05000870001 | 2CP05000870003 | 2CP05000870004 | 2CP05000870005 | 2CP05000870006 |
| <b>7</b> Front Bumper<br>Pára-choques Frontal      | 2CP06200870001 | -              | 2CP06200870004 | 2CP06200870005 | 2CP06200870006 |
| <b>8</b> Rear Bumper<br>Pára-choques trás          | 2CP06300870001 | -              | 2CP06300870004 | 2CP06300870005 | 2CP06300870006 |
| <b>9</b> Bottom side bar<br>Embaladeiras           | 2CP05700870001 | -              | 2CP05700870004 | 2CP05700870005 | 2CP05700870006 |
| <b>10</b> Rear extenders<br>Alargadores de trás    | 2CP05200440001 | -              | 2CP05200440004 | 2CP05200440005 | 2CP05200440006 |
| <b>11</b> Front extenders<br>Alargadores da frente | 2CP05200440001 | -              | 2CP05200440004 | 2CP05200440005 | 2CP05200440006 |
| <b>12</b> Roof<br>Tejadilho                        | -              | 2CP17500870003 | 2CP17500870004 | 2CP17500870005 | 2CP17500870006 |

## DTC

### RZR 1000 14-15

● BLACK ● BLUE ● RED ○ WHITE ● YELLOW ● ORANGE

|   |                |                |                |                |                |                |
|---|----------------|----------------|----------------|----------------|----------------|----------------|
| <b>0</b> Complet Kit<br>Kit Completo          | 2CP14700870300 | 2CP14700870400 | 2CP14700870500 | 2CP14700870600 | 2CP14700870700 | 2CP14700870800 |
| <b>1</b> Front A-arms<br>Triângulos da frente | 2CP04500870300 | 2CP04500870400 | 2CP04500870500 | 2CP04500870600 | 2CP04500870700 | 2CP04500870800 |
| <b>2</b> Rear A-arms<br>Triângulos de trás    | 2CP11600870300 | 2CP11600870400 | 2CP11600870500 | 2CP11600870600 | 2CP11600870700 | 2CP11600870800 |
| <b>3</b> Central Carter<br>Carter Central     | 2CP14300870300 | 2CP14300870400 | 2CP14300870500 | 2CP14300870600 | 2CP14300870700 | 2CP14300870800 |
| <b>4</b> Front Carter<br>Carter Frente        | 2CP14400870300 | 2CP14400870400 | 2CP14400870500 | 2CP14400870600 | 2CP14400870700 | 2CP14400870800 |
| <b>5</b> Rear Carter<br>Carter Trás           | 2CP14500870300 | 2CP14500870400 | 2CP14500870500 | 2CP14500870600 | 2CP14500870700 | 2CP14500870800 |
| <b>7</b> Roof 6mm<br>Tejadilho 6mm            | 2CP17300870300 | -              | -              | -              | -              | -              |



**sports quad**  
racing  
protection



# 65

## » Protect the important with CrossPro

The CrossPro offer you a wide range of aluminum and DTC protections, with highest quality, to protect your bike.

Accessories such as Bumpers, Nerf Bars and Chassis Protectors are the perfect set for the practice of all-terrain. Developed using the best raw materials and with support of improved production techniques, the CrossPro protections are essential to enjoy the most with your bike.

Ride and enjoy it

## » Protege o mais importante com Crosspro

A CrossPro oferece uma vasta gama de protecções em alumínio e DTC, da mais elevada qualidade, para proteger a sua moto.

Acessórios como Pára-choques, Nerf Bars e Protecções de chassis constituem o conjunto perfeito para a prática de Todo-o-terreno.

Desenvolvidas com recurso às melhores matérias-primas e com suporte das melhores técnicas de produção, as protecções CrossPro são uma peça fundamental para usufruir ao máximo da sua moto.

Ride and enjoy it



# BAS SERIES

## BUMPER



**66**





| ACCESS                 | GLIESE         | WASPE LITE     | WASPE          | HAT            | COROT          | SUPPORT        |
|------------------------|----------------|----------------|----------------|----------------|----------------|----------------|
| <b>450 SP</b>          | 2CP0220064**** | 2CP0230064**** | 2CP0240064**** | 2CP0250064**** | 2CP0260064**** | 2CP0370064**** |
| ADLY                   | GLIESE         | WASPE LITE     | WASPE          | HAT            | COROT          | SUPPORT        |
| <b>500 Herkules S</b>  | 2CP0220068**** | 2CP0230068**** | 2CP0240068**** | 2CP0250068**** | 2CP0260068**** | 2CP0370068**** |
| ARCTIC CAT             | GLIESE         | WASPE LITE     | WASPE          | HAT            | COROT          | SUPPORT        |
| <b>400 DVX</b>         | 2CP0220002**** | 2CP0230002**** | 2CP0240002**** | 2CP0250002**** | 2CP0260002**** | 2CP0370002**** |
| CAN-AM                 | GLIESE         | WASPE LITE     | WASPE          | HAT            | COROT          | SUPPORT        |
| <b>450 DS EFI</b>      | 2CP0220022**** | 2CP0230022**** | 2CP0240022**** | 2CP0250022**** | 2CP0260022**** | 2CP0370022**** |
| HONDA                  | GLIESE         | WASPE LITE     | WASPE          | HAT            | COROT          | SUPPORT        |
| <b>400 TRX</b>         | 2CP0220002**** | 2CP0230002**** | 2CP0240002**** | 2CP0250002**** | 2CP0260002**** | 2CP0370002**** |
| <b>450 TRX</b>         | 2CP0220002**** | 2CP0230002**** | 2CP0240002**** | 2CP0250002**** | 2CP0260002**** | 2CP0370002**** |
| <b>700 TRX XX</b>      | 2CP0220051**** | 2CP0230051**** | 2CP0240051**** | 2CP0250051**** | 2CP0260051**** | 2CP0370051**** |
| KAWASAKI               | GLIESE         | WASPE LITE     | WASPE          | HAT            | COROT          | SUPPORT        |
| <b>400 KFX</b>         | 2CP0220002**** | 2CP0230002**** | 2CP0240002**** | 2CP0250002**** | 2CP0260002**** | 2CP0370002**** |
| <b>450 KFX</b>         | 2CP0220005**** | 2CP0230005**** | 2CP0240005**** | 2CP0250005**** | 2CP0260005**** | 2CP0370005**** |
| KTM                    | GLIESE         | WASPE LITE     | WASPE          | HAT            | COROT          | SUPPORT        |
| <b>450/525 SX/XC</b>   | 2CP0220017**** | 2CP0230017**** | 2CP0240017**** | 2CP0250017**** | 2CP0260017**** | 2CP0370017**** |
| POLARIS                | GLIESE         | WASPE LITE     | WASPE          | HAT            | COROT          | SUPPORT        |
| <b>500 Outlaw</b>      | 2CP0220016**** | 2CP0230016**** | 2CP0240016**** | 2CP0250016**** | 2CP0260016**** | 2CP0370016**** |
| <b>500 Predator</b>    | 2CP0220014**** | 2CP0230014**** | 2CP0240014**** | 2CP0250014**** | 2CP0260014**** | 2CP0370014**** |
| <b>525 Outlaw</b>      | 2CP0220044**** | 2CP0230044**** | 2CP0240044**** | 2CP0250044**** | 2CP0260044**** | 2CP0370044**** |
| SUZUKI                 | GLIESE         | WASPE LITE     | WASPE          | HAT            | COROT          | SUPPORT        |
| <b>250 LTZ</b>         | 2CP0220030**** | 2CP0230030**** | 2CP0240030**** | 2CP0250030**** | 2CP0260030**** | 2CP0370030**** |
| <b>400 LTZ</b>         | 2CP0220002**** | 2CP0230002**** | 2CP0240002**** | 2CP0250002**** | 2CP0260002**** | 2CP0370002**** |
| <b>450 LTR</b>         | 2CP0220001**** | 2CP0230001**** | 2CP0240001**** | 2CP0250001**** | 2CP0260001**** | 2CP0370001**** |
| YAMAHA                 | GLIESE         | WASPE LITE     | WASPE          | HAT            | COROT          | SUPPORT        |
| <b>350 YFM Raptor</b>  | 2CP0220008**** | 2CP0230008**** | 2CP0240008**** | 2CP0250008**** | 2CP0260008**** | 2CP0370008**** |
| <b>350 YFM Warrior</b> | 2CP0220031**** | 2CP0230031**** | 2CP0240031**** | 2CP0250031**** | 2CP0260031**** | 2CP0370031**** |
| <b>350 YFZ Banshee</b> | 2CP0220023**** | 2CP0230023**** | 2CP0240023**** | 2CP0250023**** | 2CP0260023**** | 2CP0370023**** |
| <b>450 YFZ</b>         | 2CP0220004**** | 2CP0230004**** | 2CP0240004**** | 2CP0250004**** | 2CP0260004**** | 2CP0370004**** |
| <b>450 YFZ R</b>       | 2CP0220055**** | 2CP0230055**** | 2CP0240055**** | 2CP0250055**** | 2CP0260055**** | 2CP0370055**** |
| <b>660 YFM Raptor</b>  | 2CP0220009**** | 2CP0230009**** | 2CP0240009**** | 2CP0250009**** | 2CP0260009**** | 2CP0370009**** |
| <b>700 YFM Raptor</b>  | 2CP0220003**** | 2CP0230003**** | 2CP0240003**** | 2CP0250003**** | 2CP0260003**** | 2CP0370003**** |

BUMPER

COLOR MODEL

| TUBE COLOR       | ●BLACK | ●BLUE | ●RED | ●YELLOW | ●ORANGE |
|------------------|--------|-------|------|---------|---------|
| <b>Ice Matte</b> | 0301   | 0401  | 0501 | 0701    | 0801    |
| <b>Polish</b>    | 0302   | 0402  | 0502 | 0702    | 0802    |
| <b>Black</b>     | 0304   | 0404  | 0504 | 0704    | 0804    |
| <b>Blue</b>      | 0311   | 0411  | 0511 | 0711    | 0811    |
| <b>Red</b>       | 0307   | 0407  | 0507 | 0707    | 0807    |
| <b>White</b>     | 0306   | 0406  | 0506 | 0706    | 0806    |
| <b>Yellow</b>    | 0308   | 0408  | 0508 | 0708    | 0808    |
| <b>Orange</b>    | 0310   | 0410  | 0510 | 0710    | 0810    |
| <b>Green</b>     | 0309   | 0409  | 0509 | 0709    | 0809    |

- » Replace the (\*\*\*\*) for the code of the desired color Example: Red Color 2CP0220064**0806**
- » Substituir os (\*\*\*\*) pelo código de cor pretendida:Exemplo: para a cor vermelha 2CP0220064**0806**

## BAS SERIES BUMPER

- |   |   |
|---|---|
| <ul style="list-style-type: none"> <li>»Innovative design</li> <li>»Perfect Bumper for Racing or Recreation</li> <li>»All Precision TIG Welded</li> <li>»Light weight and Maximum Resistance</li> <li>»BAS (Bumpers Adjustment System), a new fitting system that allows the adjustment in depth, height and frontal angle of each Bumper</li> <li>»System tested in competition</li> <li>»Easy to mount</li> <li>»High resistance to impact</li> </ul> | <ul style="list-style-type: none"> <li>»Design Atraente e Inovador</li> <li>»Pára-Choques perfeito para competição ou lazer</li> <li>»Soldado com tecnologia TIG</li> <li>»Leveza e Máxima Resistência</li> <li>»BAS (Bumper Adjustment System) – novo sistema de fixação que permite o ajuste em altura e em inclinação do Pára-Choques</li> <li>»Sistema testado em competição</li> <li>»Fácil Montagem</li> <li>»Elevada resistência ao Impacto</li> </ul> |
|---|---|



**CROSSPRO**

- »Standard Design
- »Extremely light
- »Vented Frontal Plate
- »Maximum protection
- »Strong aluminum tubing (T6061) - 35mm
- »Tig welded for extra strength
- »Race tested and proved
- »Perfect for MX Racing

- »Design Standard
- »Extremamente Leve
- »Placa Frontal Ventilada
- »Máxima Protecção
- »Tubo de alumínio de elevada resistência (T6061) - 35mm
- »Soldado a TIG para extra durabilidade
- »Testado em competição
- »Pára-Choques Perfeito para QX

**68**

**P-SERIES**  
**BUMPER**

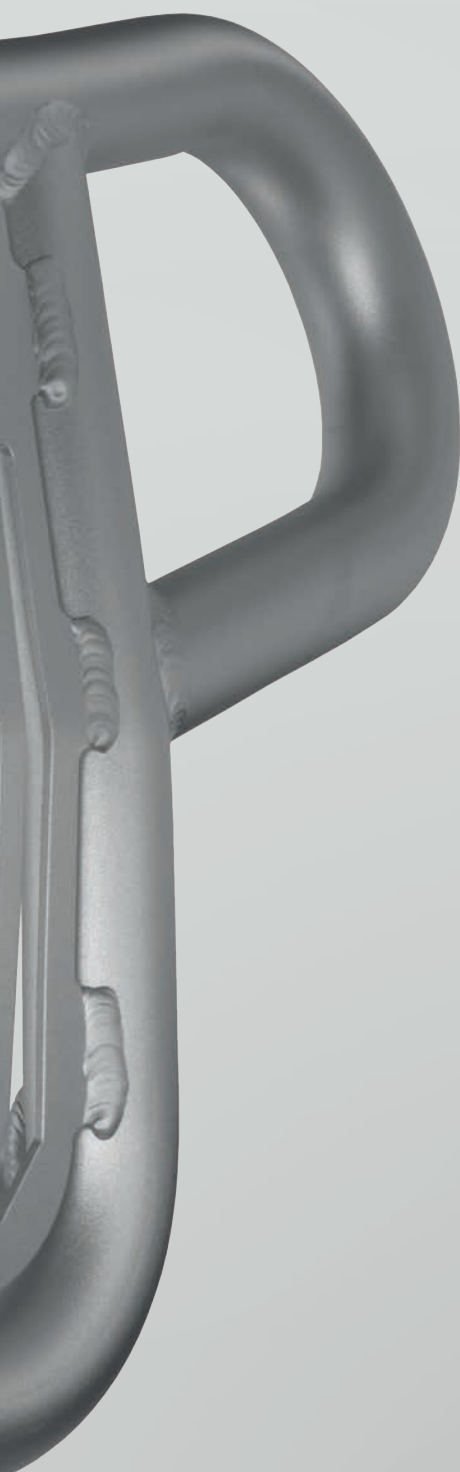

|                  | P21            | P25            | P30            | P35            |
|------------------|----------------|----------------|----------------|----------------|
| <b>ACCESS</b>    |                |                |                |                |
| 300 SP           | -              | 2CP0170070**** | -              | -              |
| 450 SP           | 2CP0160064**** | 2CP0170064**** | -              | 2CP0190064**** |
| <b>ADLY</b>      |                |                |                |                |
| 300 Herkules XS  | 2CP0160061**** | 2CP0170061**** | 2CP0180061**** | -              |
| <b>AEON</b>      |                |                |                |                |
| 350 Cobra        | 2CP0160074**** | 2CP0170074**** | 2CP0180074**** | 2CP0190074**** |
| <b>ACTIC CAT</b> |                |                |                |                |
| 250 DVX          | 2CP0160011**** | 2CP0170011**** | 2CP0180011**** | -              |
| 400 DVX          | 2CP0160002**** | 2CP0170002**** | 2CP0180002**** | 2CP0190002**** |
| <b>CAN-AM</b>    |                |                |                |                |
| 250 DS           | 2CP0160058**** | 2CP0170058**** | 2CP0180058**** | -              |
| 450 DS EFI       | 2CP0160022**** | 2CP0170022**** | 2CP0180022**** | 2CP0190022**** |
| 650 DS           | 2CP0160027**** | 2CP0170027**** | -              | -              |
| <b>DINLI</b>     |                |                |                |                |
| 450 DL           | -              | 2CP0170020**** | -              | -              |
| 450 DMX          | 2CP0160075**** | 2CP0170075**** | 2CP0180075**** | 2CP0190075**** |
| <b>ETON</b>      |                |                |                |                |
| 300 Vector ST    | 2CP0160021**** | -              | -              | 2CP0190021**** |
| <b>GOES</b>      |                |                |                |                |
| 350 S            | 2CP0160054**** | 2CP0170054**** | 2CP0180054**** | 2CP0190054**** |
| 450 X            | 2CP0160019**** | 2CP0170019**** | 2CP0180019**** | -              |
| <b>HONDA</b>     |                |                |                |                |
| 250 TRX          | 2CP0160025**** | -              | -              | -              |
| 400 TRX          | 2CP0160002**** | 2CP0170002**** | 2CP0180002**** | 2CP0190002**** |
| 450 TRX          | 2CP0160002**** | 2CP0170002**** | 2CP0180002**** | 2CP0190002**** |
| 700 TRX XX       | 2CP0160051**** | 2CP0170051**** | 2CP0180051**** | 2CP0190051**** |
| <b>HYOSUNG</b>   |                |                |                |                |
| 450 TE           | 2CP0160019**** | 2CP0170019**** | 2CP0180019**** | -              |
| <b>KAWASAKI</b>  |                |                |                |                |
| 400 KFX          | 2CP0160002**** | 2CP0170002**** | 2CP0180002**** | 2CP0190002**** |
| 450 KFX          | 2CP0160005**** | 2CP0170005**** | 2CP0180005**** | 2CP0190005**** |
| 700 KFX          | 2CP0160024**** | 2CP0170024**** | 2CP0180024**** | -              |
| <b>KTM</b>       |                |                |                |                |
| 450/525 SX/XC    | 2CP0160017**** | 2CP0170017**** | 2CP0180017**** | 2CP0190017**** |
| <b>KYMCO</b>     |                |                |                |                |
| 250 KXR          | 2CP0160010**** | 2CP0170010**** | 2CP0180010**** | -              |
| 300 KXR          | 2CP0160010**** | 2CP0170010**** | 2CP0180010**** | -              |
| <b>POLARIS</b>   |                |                |                |                |
| 400 Trailblazer  | 2CP0160028**** | 2CP0170028**** | 2CP0180028**** | -              |
| 500 Outlaw       | 2CP0160016**** | 2CP0170016**** | 2CP0180016**** | -              |
| 500 Predator     | 2CP0160014**** | 2CP0170014**** | 2CP0180014**** | 2CP0190014**** |
| 500 Scrambler    | 2CP0160028**** | 2CP0170028**** | 2CP0180028**** | -              |
| 525 Outlaw       | 2CP0160044**** | 2CP0170044**** | 2CP0180044**** | 2CP0190044**** |
| <b>SMC</b>       |                |                |                |                |
| 520 RAM          | 2CP0160065**** | 2CP0170065**** | 2CP0180065**** | 2CP0190065**** |
| <b>SUZUKI</b>    |                |                |                |                |
| 250 LTZ          | 2CP0160030**** | 2CP0170030**** | -              | 2CP0190030**** |
| 400 LTZ          | 2CP0160002**** | 2CP0170002**** | 2CP0180002**** | 2CP0190002**** |
| 450 LTR          | 2CP0160001**** | 2CP0170001**** | 2CP0180001**** | 2CP0190001**** |
| <b>YAMAHA</b>    |                |                |                |                |
| 200 YFS Blaster  | 2CP0160026**** | 2CP0170026**** | 2CP0180026**** | 2CP0190026**** |
| 250 YFM Raptor   | 2CP0160018**** | 2CP0170018**** | 2CP0180018**** | 2CP0190018**** |
| 350 YFM Raptor   | 2CP0160008**** | 2CP0170008**** | -              | 2CP0190008**** |
| 350 YFM Warrior  | 2CP0160031**** | 2CP0170031**** | 2CP0180031**** | 2CP0190031**** |
| 450 YFZ Banshee  | 2CP0160023**** | 2CP0170023**** | -              | 2CP0190023**** |
| 350 YFZ          | 2CP0160004**** | 2CP0170004**** | 2CP0180004**** | 2CP0190004**** |
| 450 YFZ R        | 2CP0160055**** | 2CP0170055**** | 2CP0180055**** | 2CP0190055**** |
| 660 YFM Raptor   | 2CP0160009**** | 2CP0170009**** | 2CP0180009**** | 2CP0190009**** |
| 700 YFM Raptor   | 2CP0160003**** | 2CP0170003**** | 2CP0180003**** | 2CP0190003**** |

» Replace the (\*\*\*\*) for the code of the desired color Example: Red Color 2CP01700510007

» Substituir os (\*\*\*\*) pelo código de cor pretendida:Exemplo: para a cor vermelha 2CP01700510007

»0001  
Ice Matte  
Ice Polish

»0002  
Polish  
Polido

»0004  
Black  
Preto

»0011  
Blue  
Azul

»0007  
Red  
Vermelho

»0006  
White  
Branco

»0008  
Yellow  
Amarelo

»0010  
Orange  
Laranja

»0009  
Green  
Verde

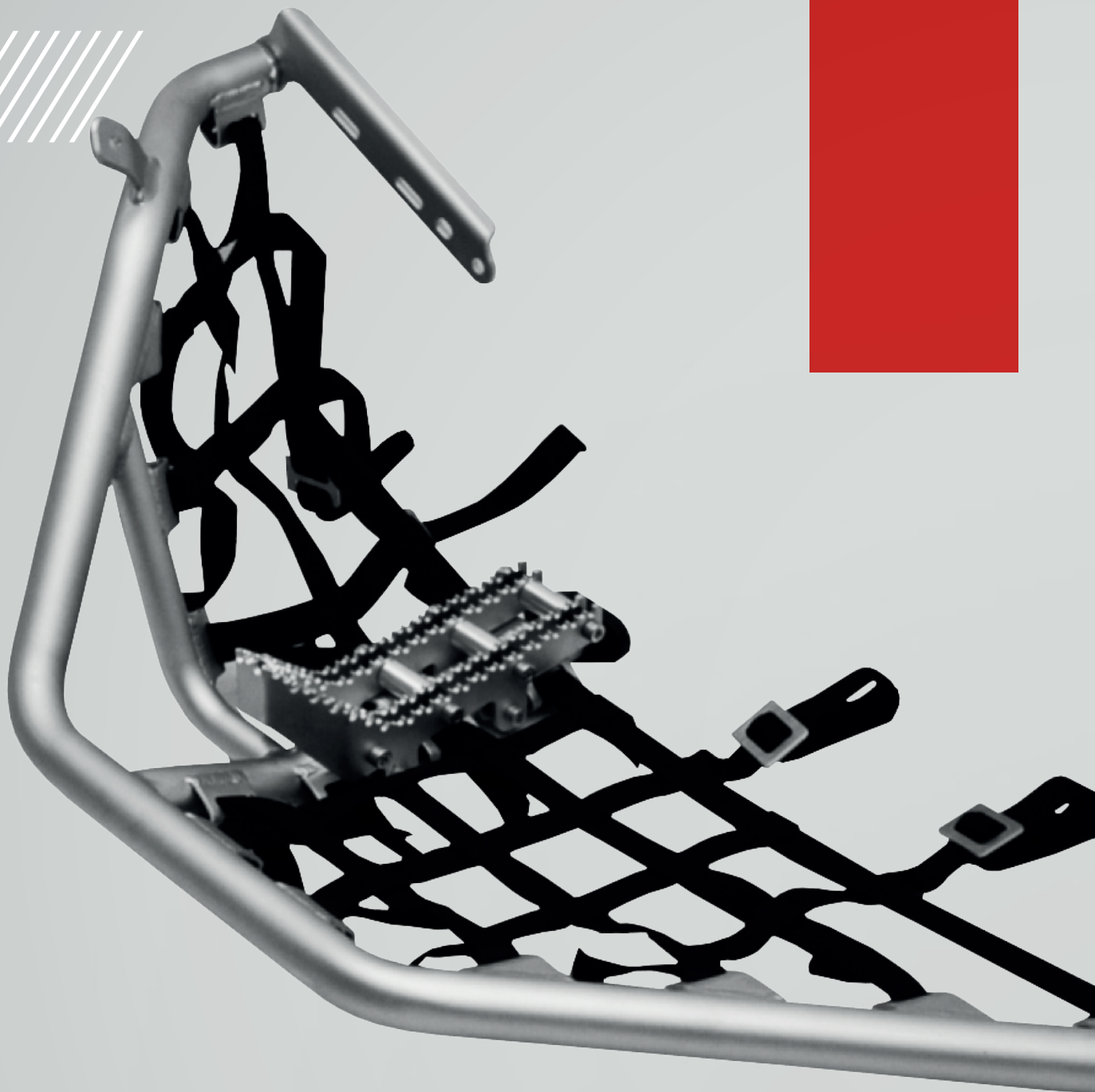

»Aluminum tube (T6061)- 35mm for high resistance  
»TIG welded for extra strength  
»Perfect for recreation or competition

»Tubo de alumínio de elevada resistência (T6061) – 35mm  
»Soldado a TIG para extra durabilidade  
»Perfeito para Lazer ou competição

**70**

**HARD RACING**  
**NERF BAR**



www.crosspro.pt

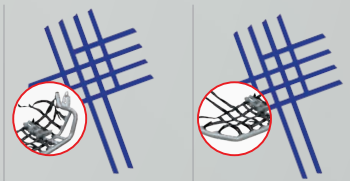
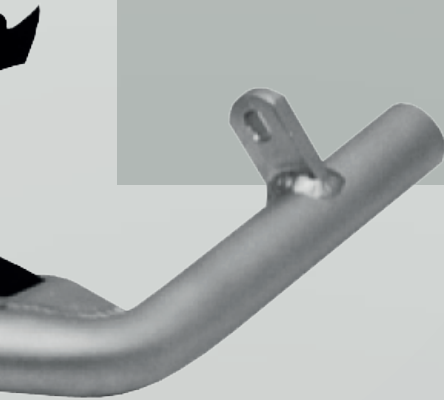

**HONDA**

450 TRX 07-»

| ● ICE MATE     | ● POLISH       | ● BLACK        | ○ WHITE        | BELT          | BELT          |
|----------------|----------------|----------------|----------------|---------------|---------------|
| 2CP13500150001 | 2CP13500150002 | 2CP13500150004 | 2CP13500150006 | 2CP1410043*** | 2CP1410044*** |

**KAWASAKI**

450 KFX

| ● ICE MATE     | ● POLISH       | ● BLACK        | ○ WHITE        | BELT          | BELT          |
|----------------|----------------|----------------|----------------|---------------|---------------|
| 2CP13500050001 | 2CP13500050002 | 2CP13500050004 | 2CP13500050006 | 2CP1410043*** | 2CP1410044*** |

**SUZUKI**

450 LTR

| ● ICE MATE     | ● POLISH       | ● BLACK        | ○ WHITE        | BELT          | BELT          |
|----------------|----------------|----------------|----------------|---------------|---------------|
| 2CP13500010001 | 2CP13500010002 | 2CP13500010004 | 2CP13500010006 | 2CP1410043*** | 2CP1410044*** |

**YAMAHA**

450 YFZ R 09-»

| ● ICE MATE     | ● POLISH       | ● BLACK        | ○ WHITE        | BELT          | BELT          |
|----------------|----------------|----------------|----------------|---------------|---------------|
| 2CP13500550001 | 2CP13500550002 | 2CP13500550004 | 2CP13500550006 | 2CP1410043*** | 2CP1410044*** |

» Replace the (\*\*\*\*) for the code of the desired color Example: Red Color 2CP13500510007

» Substituir os (\*\*\*\*) pelo código de cor pretendida:Exemplo: para a cor vermelha 2CP13500510007

● »0001  
Ice Matte  
Ice Polish

○ »0002  
Polish  
Polido

● »0004  
Black  
Preto

● »0011  
Blue  
Azul

● »0007  
Red  
Vermelho

○ »0006  
White  
Branco

● »0008  
Yellow  
Amarelo

● »0010  
Orange  
Laranja

● »0009  
Green  
Verde

»Aluminum tube (T6061)- 35mm for high resistance  
 »TIG welded for extra strength  
 »Perfect for recreation or competition

»Tubo de alumínio de elevada resistência (T6061) - 35mm  
 »Soldado a TIG para extra durabilidade  
 »Perfeito para Lazer ou competição

# FIRST STEPS NERF BAR

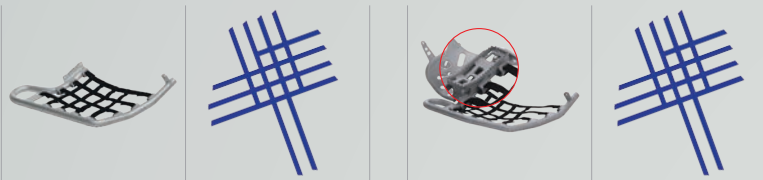

# 72

|                   | ECO-SERIES            | BELT           | EVO 1                 | BELT           |
|-------------------|-----------------------|----------------|-----------------------|----------------|
| <b>ACCESS</b>     |                       |                |                       |                |
| 450 SP            | 2CP0010064****        | 2CP1410006**** | -                     | -              |
| <b>ARCTIC CAT</b> |                       |                |                       |                |
| 250 DVX           | 2CP0010011****        | 2CP1410005**** | 2CP0020091****        | 2CP1410005**** |
| 400 DVX           | (Replaced by ECO-PRO) | -              | 2CP0020012****        | 2CP1410018**** |
| <b>BASHAN</b>     |                       |                |                       |                |
| 200 Catbrier      | 2CP0010032****        | 2CP1410013**** | -                     | -              |
| <b>CAN-AM</b>     |                       |                |                       |                |
| 250 DS            | 2CP0010058****        | 2CP1410013**** | -                     | -              |
| 450 DS EFI        | 2CP0010022****        | 2CP1410021**** | 2CP0020022****        | 2CP1410001**** |
| 650 DS            | 2CP0010027****        | 2CP1410010**** | 2CP0020027****        | 2CP1410010**** |
| <b>DINLI</b>      |                       |                |                       |                |
| 450 DL            | 2CP0010020****        | 2CP1410022**** | 2CP0020020****        | 2CP1410023**** |
| <b>GOES</b>       |                       |                |                       |                |
| 450 X             | 2CP0010019****        | 2CP1410009**** | 2CP0020019****        | 2CP1410001**** |
| <b>HONDA</b>      |                       |                |                       |                |
| 250 TRX           | 2CP0010025****        | 2CP1410002**** | -                     | -              |
| 400 TRX «-2007    | 2CP001007A****        | 2CP1410027**** | 2CP0020007****        | 2CP1410018**** |
| 400 TRX 2008-»    | 2CP001007A****        | 2CP1410027**** | 2CP002007A****        | 2CP1410018**** |
| 450 TRX «-2006    | 2CP0010006****        | 2CP1410010**** | 2CP0020006****        | 2CP1410018**** |
| 450 TRX 2007-»    | 2CP0010015****        | 2CP1410013**** | 2CP0020015****        | 2CP1410001**** |
| 700 TRX XX        | 2CP0010051****        | 2CP1410006**** | * 2CP0020051****      | 2CP1410001**** |
| <b>HYOSUNG</b>    |                       |                |                       |                |
| 450 TE            | 2CP0010019****        | 2CP1410009**** | 2CP0020019****        | 2CP1410001**** |
| <b>KAWASAKI</b>   |                       |                |                       |                |
| 400 KFX           | (Replaced by ECO-PRO) | -              | (Replaced by EVO-PRO) | -              |
| 450 KFX           | (Replaced by ECO-PRO) | -              | (Replaced by EVO-PRO) | -              |
| 700 KFX           | 2CP0010024****        | 2CP1410013**** | 2CP0020024****        | 2CP1410010**** |
| <b>KTM</b>        |                       |                |                       |                |
| 450/525 SX/XC     | (Replaced by ECO-PRO) | -              | (Replaced by EVO-PRO) | 2CP1410001**** |
| <b>KYMCO</b>      |                       |                |                       |                |
| 250 KXR           | 2CP001011A****        | 2CP1410005**** | 2CP0020011****        | 2CP1410004**** |
| 300 KXR           | 2CP001011A****        | 2CP1410005**** | 2CP0020011****        | 2CP1410004**** |
| <b>POLARIS</b>    |                       |                |                       |                |
| 500 Outlaw        | 2CP0010016****        | 2CP1410006**** | 2CP0020016****        | 2CP1410001**** |
| 500 Predator      | 2CP0010014****        | 2CP1410007**** | 2CP0020014****        | 2CP1410001**** |
| 525 Outlaw        | 2CP0010044****        | 2CP1410007**** | 2CP0020044****        | 2CP1410001**** |
| <b>SUZUKI</b>     |                       |                |                       |                |
| 250 LTZ           | 2CP0010030****        | 2CP1410005**** | -                     | -              |
| 400 LTZ «-2008    | (Replaced by ECO-PRO) | -              | (Replaced by EVO-PRO) | -              |
| 400 LTZ 2009-»    | (Replaced by ECO-PRO) | -              | (Replaced by EVO-PRO) | -              |
| 450 LTR           | (Replaced by ECO-PRO) | 2CP1410001**** | (Replaced by EVO-PRO) | -              |
| <b>YAMAHA</b>     |                       |                |                       |                |
| 200 YFS Blaster   | 2CP0010026****        | 2CP1410016**** | -                     | -              |
| 250 YFM Raptor    | 2CP0010018****        | 2CP1410016**** | 2CP0020018****        | 2CP1410017**** |
| 350 YFM Raptor    | 2CP0010008****        | 2CP1410013**** | 2CP0020008****        | 2CP1410010**** |
| 350 YFM Warrior   | 2CP0010031****        | 2CP1410013**** | -                     | -              |
| 350 YFZ Banshee   | 2CP0010023****        | 2CP1410016**** | 2CP0020023****        | 2CP1410017**** |
| 450 YFZ           | (Replaced by ECO-PRO) | -              | (Replaced by EVO-PRO) | -              |
| 450 YFZ R         | (Replaced by ECO-PRO) | -              | * 2CP0020055****      | 2CP1410001**** |
| 660 YFM Raptor    | 2CP0010009****        | 2CP1410011**** | 2CP0020009****        | 2CP1410011**** |
| 700 YFM Raptor    | 2CP0010003****        | 2CP1410006**** | (Replaced by EVO-PRO) | -              |



\* Limited Stock



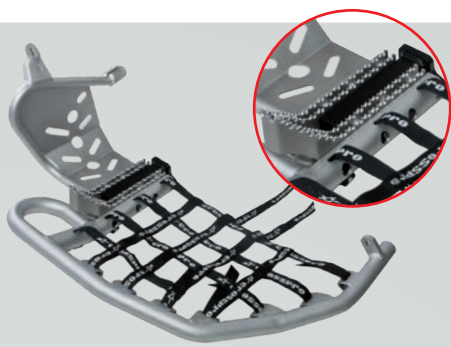

»0001 Ice Matte

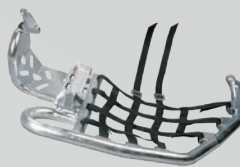

»0002 Polish / Polido

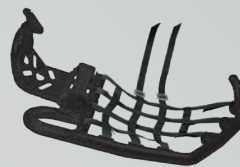

»0004 Black / Preto

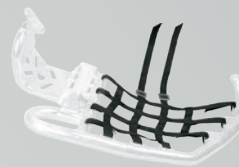

»0006 White / Branco



|                 | ECO-PRO        | BELT           | EVO-PRO        | BELT           | RACING-PRO     | BELT           | BELT           |
|-----------------|----------------|----------------|----------------|----------------|----------------|----------------|----------------|
| <b>ACCESS</b>   |                |                |                |                |                |                |                |
| 450 SP          | -              | -              | -              | -              | 2CP0060064**** | 2CP1410001**** | 2CP1410039**** |
| <b>HONDA</b>    |                |                |                |                |                |                |                |
| 450 TRX «-2006  | -              | -              | -              | -              | 2CP0060006**** | 2CP1410007**** | 2CP1410039**** |
| 450 TRX 2007-»  | -              | -              | -              | -              | 2CP0060015**** | 2CP1410007**** | 2CP1410039**** |
| 700 TRX XX      | -              | -              | 2CP0050051**** | 2CP1410006**** | 2CP0060051**** | 2CP1410006**** | 2CP1410039**** |
| <b>KAWASAKI</b> |                |                |                |                |                |                |                |
| 400 KFX         | 2CP0040002**** | 2CP1410007**** | 2CP0050002**** | 2CP1410007**** | 2CP0060002**** | 2CP1410007**** | 2CP1410039**** |
| 450 KFX         | 2CP0040005**** | 2CP1410001**** | 2CP0050005**** | 2CP1410001**** | 2CP0060005**** | 2CP1410001**** | 2CP1410039**** |
| <b>KTM</b>      |                |                |                |                |                |                |                |
| 450/525 SX/XC   | 2CP0040017**** | 2CP1410001**** | 2CP0050017**** | 2CP1410001**** | 2CP0060017**** | 2CP1410001**** | 2CP1410039**** |
| <b>SUZUKI</b>   |                |                |                |                |                |                |                |
| 400 LTZ «-2008  | 2CP0040002**** | 2CP1410007**** | 2CP0050002**** | 2CP1410007**** | 2CP0060002**** | 2CP1410007**** | 2CP1410039**** |
| 400 LTZ 2009-»  | 2CP0040048**** | 2CP1410001**** | 2CP0050048**** | 2CP1410006**** | 2CP0060048**** | 2CP1410018**** | 2CP1410039**** |
| 450 LTR         | 2CP0040001**** | 2CP1410001**** | 2CP0050001**** | 2CP1410001**** | 2CP0060001**** | 2CP1410001**** | 2CP1410039**** |
| <b>YAMAHA</b>   |                |                |                |                |                |                |                |
| 450 YFZ         | 2CP0040004**** | 2CP1410006**** | 2CP0050004**** | 2CP1410006**** | 2CP0060004**** | 2CP1410001**** | 2CP1410039**** |
| 450 YFZ R       | 2CP0040055**** | 2CP1410001**** | 2CP0050055**** | 2CP1410001**** | 2CP0060055**** | 2CP1410001**** | 2CP1410039**** |
| 660 YFM Raptor  | -              | -              | -              | -              | 2CP0060009**** | 2CP1410001**** | 2CP1410039**** |
| 700 YFM Raptor  | 2CP0040003**** | 2CP1410018**** | 2CP0050003**** | 2CP1410018**** | 2CP0060003**** | 2CP1410001**** | 2CP1410039**** |

# PRO SERIES NERF BAR



|                 |                |                |
|-----------------|----------------|----------------|
| <b>HONDA</b>    | FOOT-PEGS      | HEEL GUARDS    |
| 700 TRX XX      | 2CP0140051**** | 2CP0120051**** |
| <b>KAWASAKI</b> | FOOT-PEGS      | HEEL GUARDS    |
| 400 KFX         | 2CP0140002**** | 2CP0120002**** |
| 450 KFX         | 2CP0140005**** | 2CP0120005**** |
| <b>KTM</b>      | FOOT-PEGS      | HEEL GUARDS    |
| 450/525 SX/XC   | 2CP0140017**** | 2CP0120017**** |
| <b>SUZUKI</b>   | FOOT-PEGS      | HEEL GUARDS    |
| 400 LTZ «-2008  | 2CP0140002**** | 2CP0120002**** |
| 400 LTZ 2009-»  | 2CP0140048**** | 2CP0120048**** |
| 450 LTR         | 2CP0140001**** | 2CP0120001**** |
| <b>YAMAHA</b>   | FOOT-PEGS      | HEEL GUARDS    |
| 450 YFZ X       | 2CP0140004**** | 2CP0120004**** |
| 450 YFZ R       | 2CP0140055**** | 2CP0120055**** |
| 700 YFM Raptor  | 2CP0140003**** | 2CP0120003**** |

» Replace the (\*\*\*\*) for the code of the desired color Example: Red Color 2CP00600510007

» Substituir os (\*\*\*\*) pelo código de cor pretendida:Exemplo: para a cor vermelha 2CP00600510007

»0001  
Ice Matte  
Ice Polish

»0002  
Polish  
Polido

»0004  
Black  
Preto

»0011  
Blue  
Azul

»0007  
Red  
Vermelho

»0006  
White  
Branco

»0008  
Yellow  
Amarelo

»0010  
Orange  
Laranja

»0009  
Green  
Verde

# 74

## ALUMINIUM PROTECTION QUAD

»Produced in high quality T6061 aluminum, CrossPro protections have 4mm thickness, which combines Lightweight with maximum protection  
»Your atv will be completely protected against rock impacts that can destroy your engine  
»Spun in the fixing screws area, eliminates any fixing problems

»Produzido com alumínio da mais alta qualidade (T6061), as protecções da CrossPro são fabricada com 4mm de espessura o que combina leveza com a máxima resistência  
»O seu ATV ficará completamente protegido contra o impacto de pedras, paus ou outros objectos que podem causar danos irreversíveis  
»Repuxado na zona de fixação dos parafusos, eliminando quaisquer problemas de fixação

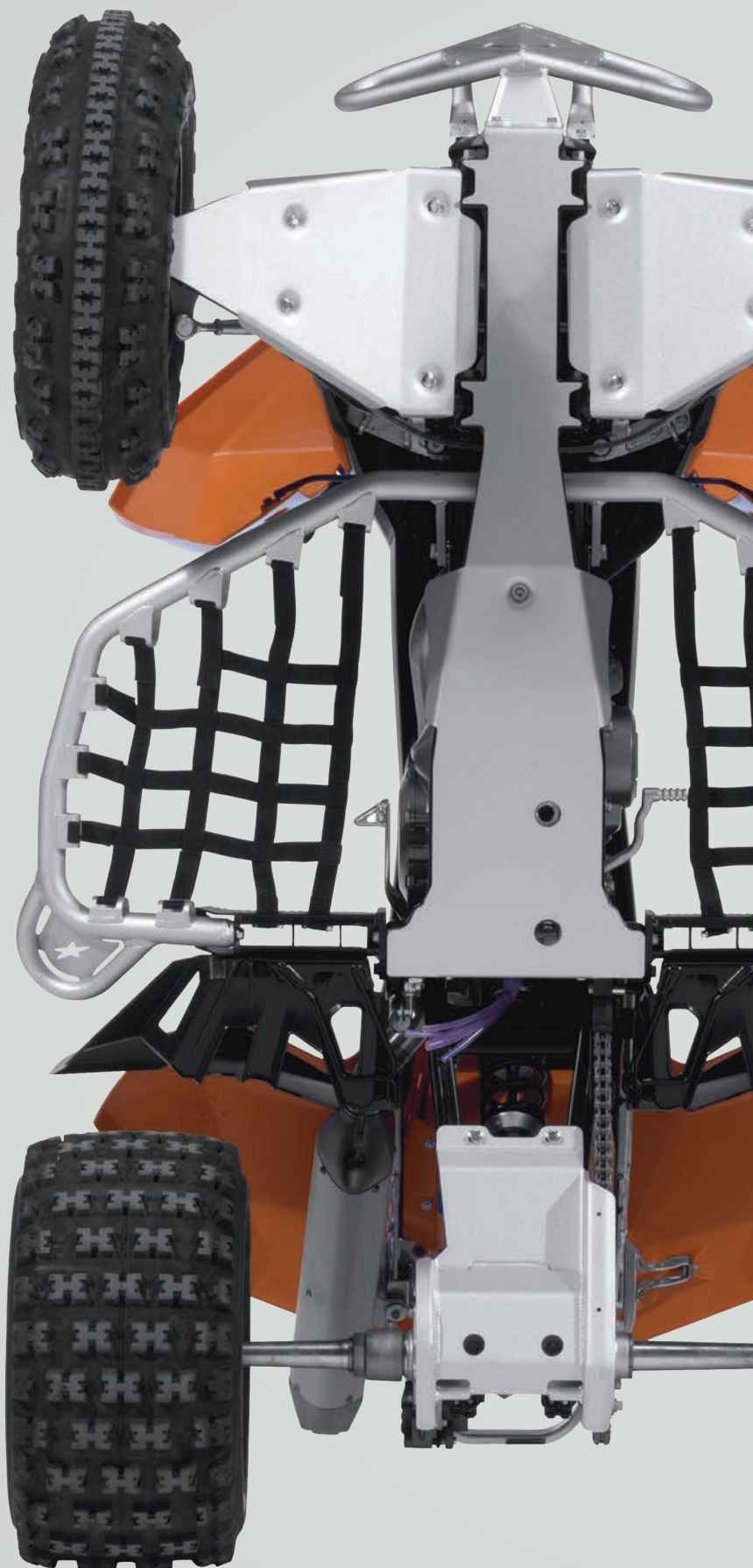

» Replace the (\*\*\*\*) for the code of the desired color Example: Red Color 2CP04000510007

» Substituir os (\*\*\*\*) pelo código de cor pretendida.Exemplo: para a cor vermelha 2CP04000510007

»0001  
Ice Matte  
Ice Polish

»0002  
Polish  
Polido

»0004  
Black  
Preto

»0011  
Blue  
Azul

»0007  
Red  
Vermelho

»0006  
White  
Branco

»0008  
Yellow  
Amarelo

»0010  
Orange  
Laranja

»0009  
Green  
Verde



| ACCESS                       | ENGINE         | A-ARMS         | FRAME          | CHAIN          | DISC           | RADIATOR       |
|------------------------------|----------------|----------------|----------------|----------------|----------------|----------------|
| <b>300 SP</b>                | -              | -              | -              | -              | 2CP0410070**** | -              |
| <b>450 SP</b>                | 2CP0400064**** | 2CP0380064**** | -              | -              | 2CP0410064**** | -              |
| <b>ADLY</b>                  | ENGINE         | A-ARMS         | FRAME          | CHAIN          | DISC           | RADIATOR       |
| <b>300 Herkules XS</b>       | 2CP0400061**** | 2CP0380061**** | -              | -              | 2CP0410061**** | -              |
| <b>320 Herkules</b>          | 2CP0400071**** | 2CP0380071**** | -              | -              | -              | -              |
| <b>500 Herkules S</b>        | 2CP0400068**** | 2CP0380068**** | -              | -              | 2CP0410068**** | -              |
| <b>AEON</b>                  | ENGINE         | A-ARMS         | FRAME          | CHAIN          | DISC           | RADIATOR       |
| <b>350 Cobra</b>             | -              | -              | -              | -              | 2CP0410073**** | -              |
| <b>ARCTIC CAT</b>            | ENGINE         | A-ARMS         | FRAME          | CHAIN          | DISC           | RADIATOR       |
| <b>250 DVX</b>               | 2CP0400011**** | 2CP0380011**** | -              | -              | 2CP0410011**** | -              |
| <b>400 DVX</b>               | 2CP040002A**** | 2CP0380002**** | 2CP0430002**** | 2CP0420002**** | 2CP0410048**** | -              |
| <b>CAN-AM</b>                | ENGINE         | A-ARMS         | FRAME          | CHAIN          | DISC           | RADIATOR       |
| <b>250 DS</b>                | -              | -              | -              | 2CP0420058**** | -              | -              |
| <b>450 DS EFI</b>            | 2CP0400022**** | 2CP0380022**** | 2CP0430022**** | -              | 2CP0410022**** | -              |
| <b>DINLI</b>                 | ENGINE         | A-ARMS         | FRAME          | CHAIN          | DISC           | RADIATOR       |
| <b>450 DL</b>                | 2CP0400020**** | 2CP0380020**** | -              | -              | 2CP0410020**** | -              |
| <b>450 DMX</b>               | -              | -              | -              | -              | 2CP0410074**** | -              |
| <b>ETON</b>                  | ENGINE         | A-ARMS         | FRAME          | CHAIN          | DISC           | RADIATOR       |
| <b>300 Vector ST</b>         | 2CP0400021**** | 2CP0380021**** | -              | -              | 2CP0410021**** | -              |
| <b>GOES</b>                  | ENGINE         | A-ARMS         | FRAME          | CHAIN          | DISC           | RADIATOR       |
| <b>350 S</b>                 | -              | 2CP0380054**** | -              | -              | 2CP0410054**** | -              |
| <b>450 X</b>                 | 2CP0400019**** | 2CP0380019**** | -              | -              | 2CP0410019**** | -              |
| <b>HONDA</b>                 | ENGINE         | A-ARMS         | FRAME          | CHAIN          | DISC           | RADIATOR       |
| <b>400 TRX</b>               | 2CP0400007**** | 2CP038007A**** | -              | 2CP042007A**** | 2CP0410007**** | -              |
| <b>450 TRX «-2006</b>        | 2CP0400006**** | 2CP0380006**** | 2CP0430006**** | 2CP0420006**** | 2CP0410006**** | -              |
| <b>450 TRX 2007-»</b>        | 2CP0400006**** | 2CP0380015**** | 2CP0430015**** | 2CP0420015**** | 2CP0410015**** | -              |
| <b>700 TRX XX</b>            | 2CP0980051**** | 2CP0380051**** | -              | -              | -              | -              |
| <b>HYOSUNG</b>               | ENGINE         | A-ARMS         | FRAME          | CHAIN          | DISC           | RADIATOR       |
| <b>450 TE</b>                | 2CP0400019**** | 2CP0380019**** | -              | -              | 2CP0410019**** | -              |
| <b>KAWASAKI</b>              | ENGINE         | A-ARMS         | FRAME          | CHAIN          | DISC           | RADIATOR       |
| <b>400 KFX</b>               | 2CP040002A**** | 2CP0380002**** | 2CP0430002**** | 2CP0420002**** | 2CP0410048**** | -              |
| <b>450 KFX</b>               | 2CP0400005**** | 2CP0380005**** | 2CP0430005**** | -              | 2CP0410005**** | -              |
| <b>700 KFX</b>               | 2CP0400024**** | 2CP0380024**** | -              | -              | 2CP0410024**** | -              |
| <b>KTM</b>                   | ENGINE         | A-ARMS         | FRAME          | CHAIN          | DISC           | RADIATOR       |
| <b>450/525 SX</b>            | 2CP0400017**** | 2CP0380073**** | 2CP0430017**** | -              | 2CP0410017**** | -              |
| <b>450/525 XC</b>            | 2CP0400017**** | 2CP0380017**** | 2CP0430017**** | -              | 2CP0410017**** | -              |
| <b>KYMCO</b>                 | ENGINE         | A-ARMS         | FRAME          | CHAIN          | DISC           | RADIATOR       |
| <b>250 KXR</b>               | 2CP0400011**** | 2CP0380010**** | -              | -              | 2CP0410011**** | -              |
| <b>300 KXR</b>               | 2CP0400011**** | 2CP0380011**** | -              | -              | 2CP0410011**** | -              |
| <b>POLARIS</b>               | ENGINE         | A-ARMS         | FRAME          | CHAIN          | DISC           | RADIATOR       |
| <b>400 Trailblazer</b>       | -              | -              | -              | -              | 2CP0410029**** | -              |
| <b>500 Outlaw</b>            | 2CP0400016**** | 2CP0380016**** | -              | -              | 2CP0410016**** | -              |
| <b>500 Predator</b>          | 2CP0400014**** | 2CP0380014**** | -              | -              | 2CP0410014**** | -              |
| <b>500 Scrambler</b>         | -              | -              | -              | -              | -              | -              |
| <b>525 Outlaw</b>            | 2CP0400044**** | 2CP0380044**** | -              | 2CP0420044**** | 2CP0410044**** | -              |
| <b>SMC</b>                   | ENGINE         | A-ARMS         | FRAME          | CHAIN          | DISC           | RADIATOR       |
| <b>520 RAM</b>               | 2CP0400065**** | 2CP0380065**** | -              | -              | 2CP0410065**** | -              |
| <b>SUZUKI</b>                | ENGINE         | A-ARMS         | FRAME          | CHAIN          | DISC           | RADIATOR       |
| <b>400 LTZ «-2008</b>        | 2CP040002A**** | 2CP0380002**** | 2CP0430002**** | 2CP0420002**** | 2CP0410048**** | -              |
| <b>400 LTZ 2009-»</b>        | 2CP040002A**** | 2CP0380048**** | 2CP0430048**** | 2CP0420048**** | 2CP0410048**** | 2CP0940048**** |
| <b>450 LTR</b>               | 2CP0400001**** | 2CP0380001**** | 2CP0430001**** | 2CP0420001**** | 2CP0410001**** | 2CP0940001**** |
| <b>TGB</b>                   | ENGINE         | A-ARMS         | FRAME          | CHAIN          | DISC           | RADIATOR       |
| <b>250 Blade</b>             | -              | 2CP0380056**** | -              | -              | 2CP0410056**** | -              |
| <b>425 Blade</b>             | -              | 2CP0380057**** | -              | -              | -              | -              |
| <b>430 Gamax</b>             | -              | -              | -              | -              | 2CP0410069**** | -              |
| <b>YAMAHA</b>                | ENGINE         | A-ARMS         | FRAME          | CHAIN          | DISC           | RADIATOR       |
| <b>200 YFS Blaster</b>       | -              | 2CP0380026**** | -              | -              | 2CP0410026**** | -              |
| <b>250 YFM Raptor</b>        | 2CP0400018**** | 2CP0380018**** | -              | 2CP0420018**** | 2CP0410018**** | -              |
| <b>350 YFM Raptor</b>        | 2CP0400008**** | 2CP0380008**** | 2CP0430008**** | -              | 2CP0410008**** | -              |
| <b>350 YFM Warrior</b>       | 2CP0400008**** | 2CP0380031**** | -              | -              | 2CP0410031**** | -              |
| <b>350 YFZ Banshee</b>       | 2CP0400023**** | 2CP0380023**** | -              | -              | 2CP0410023**** | -              |
| <b>450 YFZ «-2005</b>        | 2CP0400004**** | 2CP0380003**** | 2CP0430004**** | 2CP0420004**** | 2CP041004A**** | -              |
| <b>450 YFZ 2006</b>          | 2CP0400004**** | 2CP0380003**** | 2CP0430004**** | 2CP0420004**** | 2CP041004B**** | -              |
| <b>450 YFZ 2007-2014</b>     | 2CP0400004**** | 2CP0380003**** | 2CP0430004**** | 2CP0420004**** | 2CP041004C**** | -              |
| <b>450 YFZ R 2009-2015</b>   | 2CP040055A**** | 2CP038055A**** | 2CP0430055**** | 2CP0420055**** | 2CP041055A**** | 2CP0940055**** |
| <b>660 YFM Raptor</b>        | 2CP0400009**** | 2CP0380009**** | 2CP0430009**** | -              | 2CP0410009**** | -              |
| <b>700 YFM Raptor «-2014</b> | 2CP0400003**** | 2CP0380003**** | 2CP0430003**** | 2CP0420003**** | 2CP0410003**** | -              |
| <b>700 YFM Raptor 2015-»</b> | 2CP0400003**** | 2CP038003A**** | 2CP0430003**** | 2CP0420003**** | 2CP0410003**** | -              |

# PROTECTIONS

## DTC

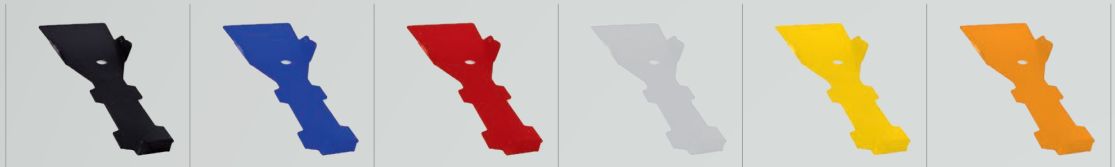

### GOES

|       | ● BLACK        | ● BLUE         | ● RED          | ○ WHITE        | ● YELLOW       | ● ORANGE       |
|-------|----------------|----------------|----------------|----------------|----------------|----------------|
| 450 X | 2CP05800190300 | 2CP05800190400 | 2CP05800190500 | 2CP05800190600 | 2CP05800190700 | 2CP05800190800 |

### ARCTIC CAT

|         | ● BLACK        | ● BLUE         | ● RED          | ○ WHITE        | ● YELLOW       | ● ORANGE       |
|---------|----------------|----------------|----------------|----------------|----------------|----------------|
| 400 DVX | 2CP058002A0300 | 2CP058002A0400 | 2CP058002A0500 | 2CP058002A0600 | 2CP058002A0700 | 2CP058002A0800 |

### HONDA

|         | ● BLACK        | ● BLUE         | ● RED          | ○ WHITE        | ● YELLOW       | ● ORANGE       |
|---------|----------------|----------------|----------------|----------------|----------------|----------------|
| 400 TRX | 2CP05800070300 | 2CP05800070400 | 2CP05800070500 | 2CP05800070600 | 2CP05800070700 | 2CP05800070800 |
| 450 TRX | 2CP05800060300 | 2CP05800060400 | 2CP05800060500 | 2CP05800060600 | 2CP05800060700 | 2CP05800060800 |

### HYOSUNG

|        | ● BLACK        | ● BLUE         | ● RED          | ○ WHITE        | ● YELLOW       | ● ORANGE       |
|--------|----------------|----------------|----------------|----------------|----------------|----------------|
| 450 TE | 2CP05800190300 | 2CP05800190400 | 2CP05800190500 | 2CP05800190600 | 2CP05800190700 | 2CP05800190800 |

### KAWASAKI

|         | ● BLACK        | ● BLUE         | ● RED          | ○ WHITE        | ● YELLOW       | ● ORANGE       |
|---------|----------------|----------------|----------------|----------------|----------------|----------------|
| 400 KFX | 2CP058002A0300 | 2CP058002A0400 | 2CP058002A0500 | 2CP058002A0600 | 2CP058002A0700 | 2CP058002A0800 |
| 450 KFX | 2CP05800050300 | 2CP05800050400 | 2CP05800050500 | 2CP05800050600 | 2CP05800050700 | 2CP05800050800 |

### KTM

|            | ● BLACK        | ● BLUE         | ● RED          | ○ WHITE        | ● YELLOW       | ● ORANGE       |
|------------|----------------|----------------|----------------|----------------|----------------|----------------|
| 450/525 XC | 2CP05800170300 | 2CP05800170400 | 2CP05800170500 | 2CP05800170600 | 2CP05800170700 | 2CP05800170800 |

### SUZUKI

|         | ● BLACK        | ● BLUE         | ● RED          | ○ WHITE        | ● YELLOW       | ● ORANGE       |
|---------|----------------|----------------|----------------|----------------|----------------|----------------|
| 400 LTZ | 2CP058002A0300 | 2CP058002A0400 | 2CP058002A0500 | 2CP058002A0600 | 2CP058002A0700 | 2CP058002A0800 |
| 450 LTR | 2CP05800010300 | 2CP05800010400 | 2CP05800010500 | 2CP05800010600 | 2CP05800010700 | 2CP05800010800 |

### YAMAHA

|                 | ● BLACK        | ● BLUE         | ● RED          | ○ WHITE        | ● YELLOW       | ● ORANGE       |
|-----------------|----------------|----------------|----------------|----------------|----------------|----------------|
| 250 YFM Raptor  | 2CP05800180300 | 2CP05800180400 | 2CP05800180500 | 2CP05800180600 | 2CP05800180700 | 2CP05800180800 |
| 350 YFM Raptor  | 2CP05800080300 | 2CP05800080400 | 2CP05800080500 | 2CP05800080600 | 2CP05800080700 | 2CP05800080800 |
| 350 YFM Warrior | 2CP05800080300 | 2CP05800080400 | 2CP05800080500 | 2CP05800080600 | 2CP05800080700 | 2CP05800080800 |
| 350 YFZ Banshee | 2CP05800230300 | 2CP05800230400 | 2CP05800230500 | 2CP05800230600 | 2CP05800230700 | 2CP05800230800 |
| 450 YFZ X       | 2CP05800040300 | 2CP05800040400 | 2CP05800040500 | 2CP05800040600 | 2CP05800040700 | 2CP05800040800 |
| 450 YFZ R       | 2CP058055A0300 | 2CP058055A0400 | 2CP058055A0500 | 2CP058055A0600 | 2CP058055A0700 | 2CP058055A0800 |
| 660 YFM Raptor  | 2CP05800090300 | 2CP05800090400 | 2CP05800090500 | 2CP05800090600 | 2CP05800090700 | 2CP05800090800 |
| 700 YFM Raptor  | 2CP05800030300 | 2CP05800030400 | 2CP05800030500 | 2CP05800030600 | 2CP05800030700 | 2CP05800030800 |

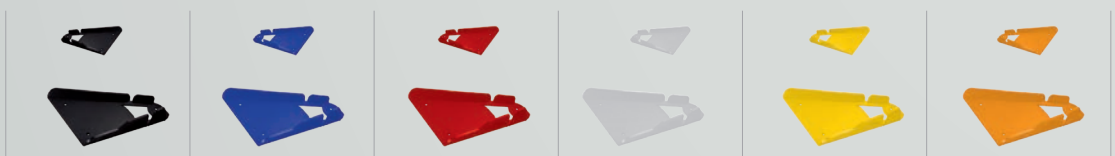

### ARCTIC CAT

|         | ● BLACK        | ● BLUE         | ● RED          | ○ WHITE        | ● YELLOW       | ● ORANGE       |
|---------|----------------|----------------|----------------|----------------|----------------|----------------|
| 400 DVX | 2CP04500020300 | 2CP04500020400 | 2CP04500020500 | 2CP04500020600 | 2CP04500020700 | 2CP04500020800 |

### HONDA

|                | ● BLACK        | ● BLUE         | ● RED          | ○ WHITE        | ● YELLOW       | ● ORANGE       |
|----------------|----------------|----------------|----------------|----------------|----------------|----------------|
| 400 TRX        | 2CP04500070300 | 2CP04500070400 | 2CP04500070500 | 2CP04500070600 | 2CP04500070700 | 2CP04500070800 |
| 450 TRX 2007-↔ | 2CP04500150300 | 2CP04500150400 | 2CP04500150500 | 2CP04500150600 | 2CP04500150700 | 2CP04500150800 |

### KAWASAKI

|         | ● BLACK        | ● BLUE         | ● RED          | ○ WHITE        | ● YELLOW       | ● ORANGE       |
|---------|----------------|----------------|----------------|----------------|----------------|----------------|
| 400 KFX | 2CP04500020300 | 2CP04500020400 | 2CP04500020500 | 2CP04500020600 | 2CP04500020700 | 2CP04500020800 |
| 450 KFX | 2CP04500050300 | 2CP04500050400 | 2CP04500050500 | 2CP04500050600 | 2CP04500050700 | 2CP04500050800 |

### KTM

|            | ● BLACK        | ● BLUE         | ● RED          | ○ WHITE        | ● YELLOW       | ● ORANGE       |
|------------|----------------|----------------|----------------|----------------|----------------|----------------|
| 450/525 XC | 2CP04500170300 | 2CP04500170400 | 2CP04500170500 | 2CP04500170600 | 2CP04500170700 | 2CP04500170800 |

### SUZUKI

|         | ● BLACK        | ● BLUE         | ● RED          | ○ WHITE        | ● YELLOW       | ● ORANGE       |
|---------|----------------|----------------|----------------|----------------|----------------|----------------|
| 400 LTZ | 2CP04500020300 | 2CP04500020400 | 2CP04500020500 | 2CP04500020600 | 2CP04500020700 | 2CP04500020800 |
| 450 LTR | 2CP04500010300 | 2CP04500010400 | 2CP04500010500 | 2CP04500010600 | 2CP04500010700 | 2CP04500010800 |

### YAMAHA

|                       | ● BLACK        | ● BLUE         | ● RED          | ○ WHITE        | ● YELLOW       | ● ORANGE       |
|-----------------------|----------------|----------------|----------------|----------------|----------------|----------------|
| 250 YFM Raptor        | 2CP04500180300 | 2CP04500180400 | 2CP04500180500 | 2CP04500180600 | 2CP04500180700 | 2CP04500180800 |
| 350 YFM Raptor        | 2CP04500080300 | 2CP04500080400 | 2CP04500080500 | 2CP04500080600 | 2CP04500080700 | 2CP04500080800 |
| 450 YFZ               | 2CP04500030300 | 2CP04500030400 | 2CP04500030500 | 2CP04500030600 | 2CP04500030700 | 2CP04500030800 |
| 450 YFZ R             | 2CP045055A0300 | 2CP045055A0400 | 2CP045055A0500 | 2CP045055A0600 | 2CP045055A0700 | 2CP045055A0800 |
| 660 YFM Raptor        | 2CP04500090300 | 2CP04500090400 | 2CP04500090500 | 2CP04500090600 | 2CP04500090700 | 2CP04500090800 |
| 700 YFM Raptor «-2014 | 2CP04500030300 | 2CP04500030400 | 2CP04500030500 | 2CP04500030600 | 2CP04500030700 | 2CP04500030800 |
| 700 YFM Raptor 2015-↔ | 2CP045003A0300 | 2CP045003A0400 | 2CP045003A0500 | 2CP045003A0600 | 2CP045003A0700 | 2CP045003A0800 |



- »Innovative concept
- »Manufactured of a high density 6mm and 8mm DTC
- »Does not rattle or vibrate
- »Do not bend or break
- »More scratch resistant than aluminum
- »Half the weight of aluminum
- »Intensely tested by top ATV pilots

- »Conceito Inovador
- »Fabricado em DTC de Alta Densidade de 6mm e 8mm.
- »Não vibra e não provoca ruído
- »Não dobra ou quebra
- »Mais resistente ao risco que o alumínio
- »Metade do peso do alumínio
- »Testado intensivamente por pilotos TOP

# DISC GUARD

## DTC

# 78

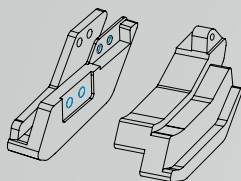

- » Innovative concept
- » Manufactured of a high density DTC
- » Does not rattle or vibrate
- » No Welds
- » Impact Resistance
- » 100% Machined
- » Intensely tested by top ATV pilots

- » Conceito Inovador
- » Fabricado em DTC de Alta Densidade.
- » Não vibra e não provoca ruído
- » Sem soldas
- » Maior resistência ao impacto
- » 100% maquinada
- » Testado intensivamente por pilotos TOP

SUZUKI

• BLACK

450 LTR

2CP120001A0300



# CASE SAVER

## DTC

\*Pinhão não incluído

\*Front sprocket not included

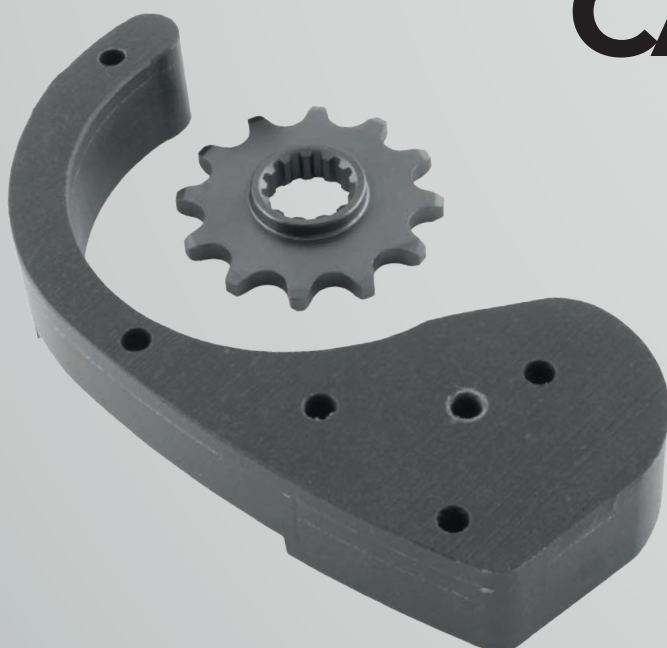

YAMAHA

• BLACK

YFZ 350 Banshee (all)

2CP12800230300



# 79

# SHOCK COVERS



»In order to ensure maximum protection of your motorcycle, CROSSPRO offers a range of dampers covers.

»These protections not only protect against dust and mud, but also against stones and other objects.

»De forma assegurar a máxima protecção da sua moto, a Crosspro oferece uma gama de capas de amortecedores.

»Estas protecções protegem não só contra o pó e lama mas também contra pedras e outros objectos.

## ARCTIC CAT

• BLACK

|         |                |
|---------|----------------|
| 250 DVX | 2CP07500910000 |
| 400 DVX | 2CP07500120000 |

## CAN-AM

• BLACK

|                   |                |
|-------------------|----------------|
| 450 DS EFI        | 2CP07500220000 |
| 650 DS            | 2CP07500270000 |
| 500/800 Outlander | 2CP07500350000 |
| 500/800 Renegade  | 2CP07500420000 |

## ETON

• BLACK

|               |                |
|---------------|----------------|
| 300 Vector ST | 2CP07500210000 |
|---------------|----------------|

## GOES

• BLACK

|         |                |
|---------|----------------|
| 350 S   | 2CP07500540000 |
| 520 Max | 2CP07500530000 |

## HONDA

• BLACK

|                |                |
|----------------|----------------|
| 400 TRX        | 2CP07500070000 |
| 450 TRX «-2006 | 2CP07500060000 |
| 450 TRX 2007-» | 2CP07500060000 |
| 680 Rincon     | 2CP07500500000 |
| 700 TRX XX     | 2CP07500510000 |

## KAWASAKI

• BLACK

|                     |                |
|---------------------|----------------|
| 400 KFX             | 2CP07300130000 |
| 450 KFX             | 2CP07500050000 |
| 700 KFX             | 2CP07500240000 |
| 750 KVF Brute Force | 2CP07500520000 |

## KTM

• BLACK

|               |                |
|---------------|----------------|
| 450/525 SX/XC | 2CP07500170000 |
|---------------|----------------|

## KYMCO

• BLACK

|         |                |
|---------|----------------|
| 250 KXR | 2CP07500100000 |
| 300 KXR | 2CP07500110000 |

## POLARIS

• BLACK

|                   |                |
|-------------------|----------------|
| 500 Outlaw        | 2CP07500160000 |
| 500 Predator      | 2CP07500140000 |
| 500 Scrambler     | 2CP07500280000 |
| 525 Outlaw        | 2CP07500440000 |
| 500/800 Sportsman | 2CP07500460000 |
| 800 RZR           | 2CP07500450000 |
| 1000 RZR          | 2CP07500870000 |

## SUZUKI

• BLACK

|                   |                |
|-------------------|----------------|
| 400 LTZ «-2008    | 2CP07500020000 |
| 400 LTZ 2009-»    | 2CP07500480000 |
| 450 LTR           | 2CP07500010000 |
| 450/700 King Quad | 2CP07500490000 |

## TGB

• BLACK

|           |                |
|-----------|----------------|
| 250 Blade | 2CP07500560000 |
| 425 Blade | 2CP07500570000 |

## YAMAHA

• BLACK

|                 |                |
|-----------------|----------------|
| 250 YFM Raptor  | 2CP07500180000 |
| 350 YFM Raptor  | 2CP07500180000 |
| 350 YFM Warrior | 2CP07500310000 |
| 350 YFZ Banshee | 2CP07500230000 |
| 450 YFZ         | 2CP07500040000 |
| 450 YFZ R       | 2CP07500550000 |
| 660 YFM Raptor  | 2CP07500090000 |
| 700 Grizzly     | 2CP07500470000 |
| 700 YFM Raptor  | 2CP07500030000 |

# REAR HOLD STANDARD



»The rear handle bars, in addition to its usual function, can also be used to support lights, plates and numbers.  
»CROSSPRO offers two models, Origin and Racing, the Racing is more complete, available in various finishing's, allows the customization of your motorcycle suited to your preferences.

»As pegas traseiras, além da sua função habitual, pode ainda ser utilizada para suporte de luzes, porta matrículas e porta números.  
»A CrossPro oferece dois modelos de pegas traseiras Tipo Origem e Racing, este último mais completo, disponíveis em vários acabamentos permite uma personalização da sua moto adequada às suas preferências.

» Replace the (\*\*\*\*) for the code of the desired color Example: Red Color 2CP0480012**0007**

» Substituir os (\*\*\*\*) pelo código de cor pretendida.Exemplo: para a cor vermelha 2CP0480012**0007**

● »0001  
Ice Matte  
Ice Polish

○ »0002  
Polish  
Polido

● »0004  
Black  
Preto

● »0011  
Blue  
Azul

● »0007  
Red  
Vermelho

○ »0006  
White  
Branco

● »0008  
Yellow  
Amarelo

● »0010  
Orange  
Laranja

● »0009  
Green  
Verde

| ACCESS         | REAR HOLD      |
|----------------|----------------|
| 450 SP         | 2CP0480064**** |
| ADLY           | REAR HOLD      |
| 500 Herkules S | 2CP0480068**** |
| ARCTIC CAT     | REAR HOLD      |
| 400 DVX        | 2CP0480002**** |
| CAN-AM         | REAR HOLD      |
| 450 DS EFI     | 2CP0480022**** |
| GOES           | REAR HOLD      |
| 350 S          | 2CP0480054**** |
| 450 X          | 2CP0480019**** |
| HONDA          | REAR HOLD      |
| 450 TRX «-2006 | 2CP0480002**** |
| 450 TRX 2007-» | 2CP0480015**** |
| 700 TRX XX     | 2CP0480051**** |

| HYOSUNG       | REAR HOLD      |
|---------------|----------------|
| 450 TE        | 2CP0480019**** |
| KAWASAKI      | REAR HOLD      |
| 400 KFX       | 2CP0480002**** |
| 450 KFX       | 2CP048005A**** |
| 700 KFX       | 2CP0480024**** |
| KTM           | REAR HOLD      |
| 450/525 SX/XC | 2CP0480017**** |
| KYMCO         | REAR HOLD      |
| 250 KXR       | 2CP0480010**** |
| 300 KXR       | 2CP0480011**** |
| POLARIS       | REAR HOLD      |
| 500 Outlaw    | 2CP0480016**** |
| 500 Predator  | 2CP0480014**** |
| 525 Outlaw    | 2CP0480016**** |

| SUZUKI                    | REAR HOLD      |
|---------------------------|----------------|
| 250 LTZ                   | 2CP0480030**** |
| 400 LTZ «-2008            | 2CP0480002**** |
| 400 LTZ 2009-»            | 2CP0480048**** |
| 450 LTR                   | 2CP048001A**** |
| YAMAHA                    | REAR HOLD      |
| 200 Blaster               | 2CP0480026**** |
| 250 YFM Raptor            | 2CP0480018**** |
| 350 YFM Raptor            | 2CP0480008**** |
| 350 YFZ Banshee           | 2CP0480023**** |
| 450 YFZ (Not for R model) | 2CP048004A**** |
| 450 YFZ (Not for R model) | 2CP048004B**** |
| 450 YFZ (Not for R model) | 2CP048004A**** |
| 450 YFZ R                 | 2CP0480055**** |
| 660 YFM Raptor            | 2CP0480009**** |
| 700 YFM Raptor            | 2CP0480003**** |

# REAR HOLD RACING

- with number plate support

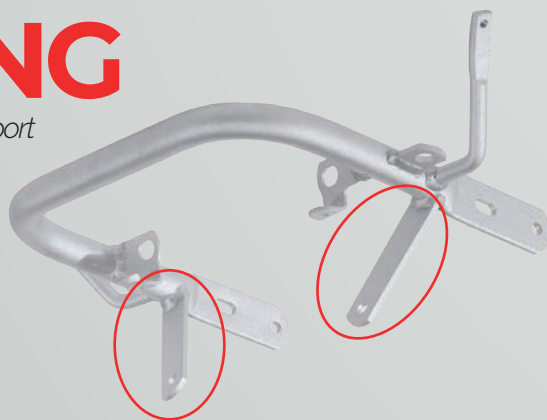

| SUZUKI            | ● ICE MATTE    | ● POLISH       | ● BLACK        | ○ WHITE        |
|-------------------|----------------|----------------|----------------|----------------|
| 400 LTZ 2009-»    | 2CP04900480001 | 2CP04900480002 | 2CP04900480004 | 2CP04900480006 |
| 450 LTR           | 2CP04900010001 | 2CP04900010002 | 2CP04900010004 | 2CP04900010006 |
| YAMAHA            | ● ICE MATTE    | ● POLISH       | ● BLACK        | ○ WHITE        |
| 450 YFZ R 2009-16 | 2CP04900550001 | 2CP04900550002 | 2CP04900550004 | 2CP04900550006 |

# 80

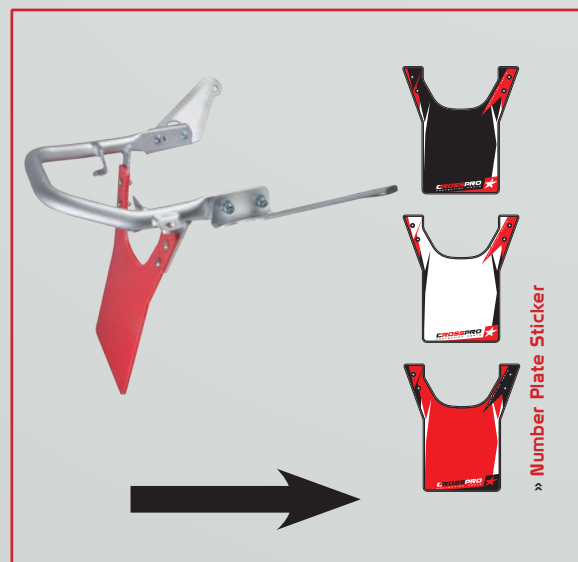

» Number Plate Sticker





# REAR HOLD RACING

- complete with number plate

»A Pega Traseira "Racing", foi desenvolvida para uma utilização em competição, o seu porta número, permite ao piloto colocar o seu número ou identificação, não interferindo com a sua condução e segurança.

»Permitindo uma completa personalização, disponível em diferentes cores e acabamentos.

»The Rear Hold "Racing", was developed for a utilization in competition, the number hold allows to the pilot to put is number or identification, without it interferes on is driving or safety.

»Allows a complete personalization, available in different colors and finishing's.



PLATE COLOR / COR DO PORTA-NUMERO

| SUZUKI           |             | TUBE COLOR     | ● BLACK        | ● BLUE         | ● RED          | ○ WHITE        | ● YELLOW       | ● ORANGE |
|------------------|-------------|----------------|----------------|----------------|----------------|----------------|----------------|----------|
| 400 LTZ 2009-»   | ● Ice Matte | 2CP04900480301 | 2CP04900480401 | 2CP04900480501 | 2CP04900480601 | 2CP04900480701 | 2CP04900480801 |          |
|                  | ● Polish    | 2CP04900480302 | 2CP04900480402 | 2CP04900480502 | 2CP04900480602 | 2CP04900480702 | 2CP04900480802 |          |
|                  | ● Black     | 2CP04900480304 | 2CP04900480404 | 2CP04900480504 | 2CP04900480604 | 2CP04900480704 | 2CP04900480804 |          |
|                  | ○ White     | 2CP04900480306 | 2CP04900480406 | 2CP04900480506 | 2CP04900480606 | 2CP04900480706 | 2CP04900480806 |          |
| 450 LTR          | ● Ice Matte | 2CP049001A0301 | 2CP049001A0401 | 2CP049001A0501 | 2CP049001A0601 | 2CP049001A0701 | 2CP049001A0801 |          |
|                  | ● Polish    | 2CP049001A0302 | 2CP049001A0402 | 2CP049001A0502 | 2CP049001A0602 | 2CP049001A0702 | 2CP049001A0802 |          |
|                  | ● Black     | 2CP049001A0304 | 2CP049001A0404 | 2CP049001A0504 | 2CP049001A0604 | 2CP049001A0704 | 2CP049001A0804 |          |
|                  | ○ White     | 2CP049001A0306 | 2CP049001A0406 | 2CP049001A0506 | 2CP049001A0606 | 2CP049001A0706 | 2CP049001A0806 |          |
| YAMAHA           |             | TUBE COLOR     | ● BLACK        | ● BLUE         | ● RED          | ○ WHITE        | ● YELLOW       | ● ORANGE |
| 450 YFZ R 2009-» | ● Ice Matte | 2CP04900550301 | 2CP04900550401 | 2CP04900550501 | 2CP04900550601 | 2CP04900550701 | 2CP04900550801 |          |
|                  | ● Polish    | 2CP04900550302 | 2CP04900550402 | 2CP04900550502 | 2CP04900550602 | 2CP04900550702 | 2CP04900550802 |          |
|                  | ● Black     | 2CP04900550304 | 2CP04900550404 | 2CP04900550504 | 2CP04900550604 | 2CP04900550704 | 2CP04900550804 |          |
|                  | ○ White     | 2CP04900550306 | 2CP04900550406 | 2CP04900550506 | 2CP04900550606 | 2CP04900550706 | 2CP04900550806 |          |

## NUMBER PLATE



| SUZUKI           |                | ● BLACK        | ● BLUE         | ● RED          | ○ WHITE        | ● YELLOW       | ● ORANGE |
|------------------|----------------|----------------|----------------|----------------|----------------|----------------|----------|
| 400 LTZ 2009-»   | 2CP09500480300 | 2CP09500480400 | 2CP09500480500 | 2CP09500480600 | 2CP09500480700 | 2CP09500480800 |          |
| 450 LTR          | 2CP09500010300 | 2CP09500010400 | 2CP09500010500 | 2CP09500010600 | 2CP09500010700 | 2CP09500010800 |          |
| YAMAHA           |                | ● BLACK        | ● BLUE         | ● RED          | ○ WHITE        | ● YELLOW       | ● ORANGE |
| 450 YFZ R 2009-» | 2CP09500550300 | 2CP09500550400 | 2CP09500550500 | 2CP09500550600 | 2CP09500550700 | 2CP09500550800 |          |
| UNIVERSAL        |                | ● BLACK        | ● BLUE         | ● RED          | ○ WHITE        | ● YELLOW       | ● ORANGE |
| Universal        | 2CP09500000300 | 2CP09500000400 | 2CP09500000500 | 2CP09500000600 | 2CP09500000700 | 2CP09500000800 |          |

## STICKERS

| SUZUKI           |                | ● BLACK        | ● RED          | ○ WHITE |
|------------------|----------------|----------------|----------------|---------|
| 400 LTZ 2009-»   | 2CP14200480300 | 2CP14200480500 | 2CP14200480600 |         |
| 450 LTR          | 2CP14200010300 | 2CP14200010500 | 2CP14200010600 |         |
| YAMAHA           |                | ● BLACK        | ● RED          | ○ WHITE |
| 450 YFZ R 2009-» | 2CP14200550300 | 2CP14200550500 | 2CP14200550600 |         |
| UNIVERSAL        |                | ● BLACK        | ● RED          | ○ WHITE |
| Universal        | 2CP14200000300 | 2CP14200000500 | 2CP14200000600 |         |

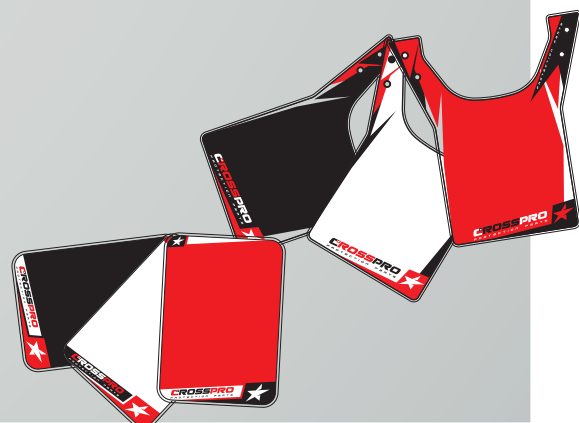





# WHEEL SPACERS

**Model: A**

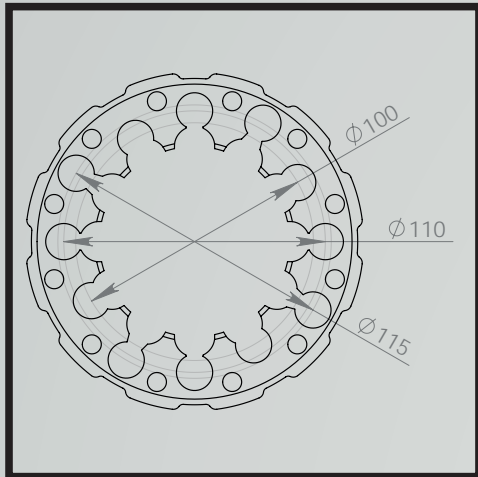

**Model: B**

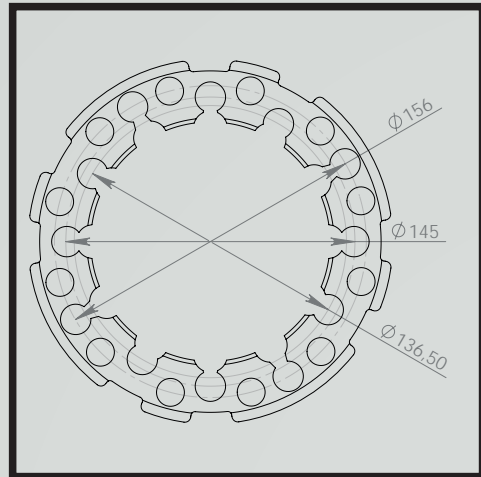

**Model: C**

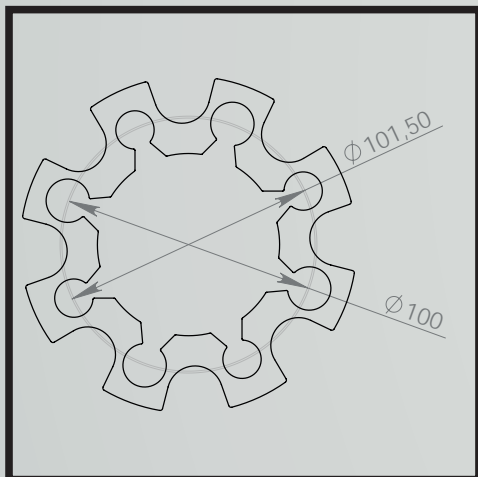

**Model: D**

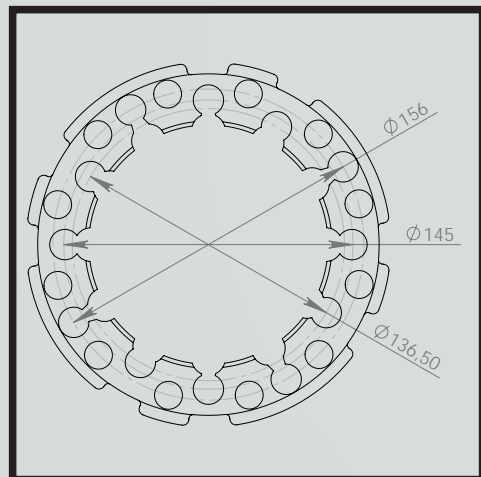

**Model: E**

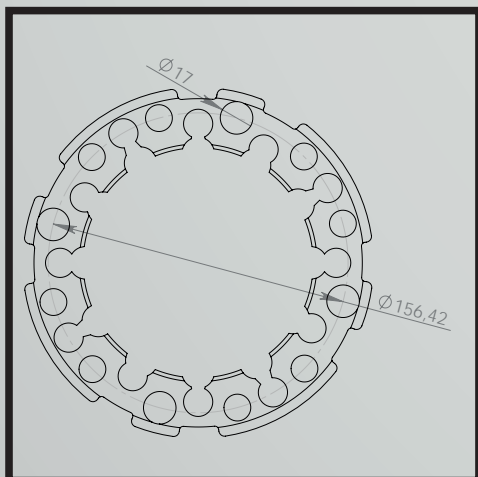

**Model: F**

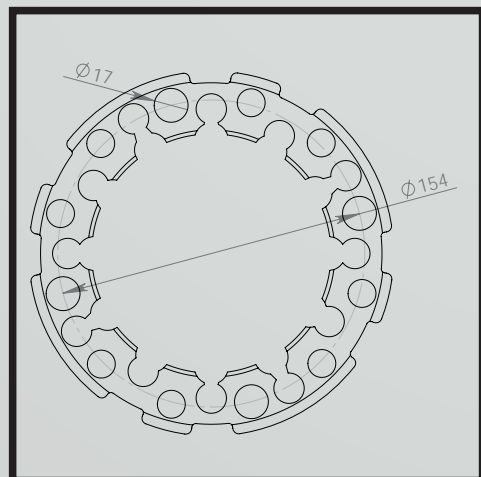

**2CP05300150000**

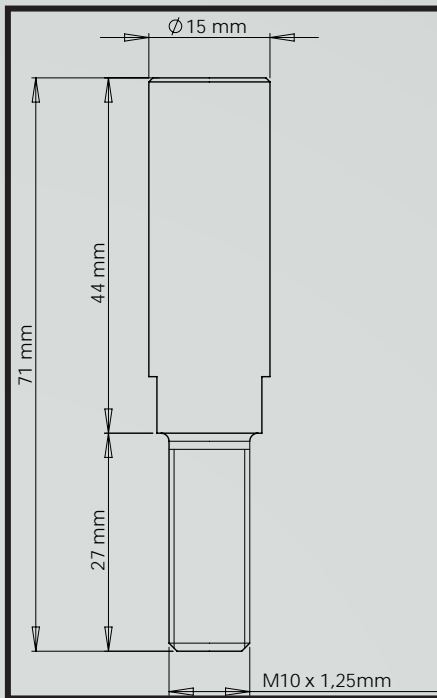

**2CP05300160000**

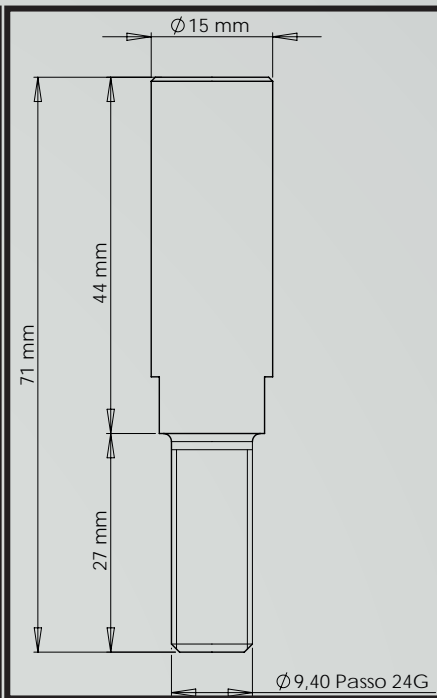

**2CP05300170000**

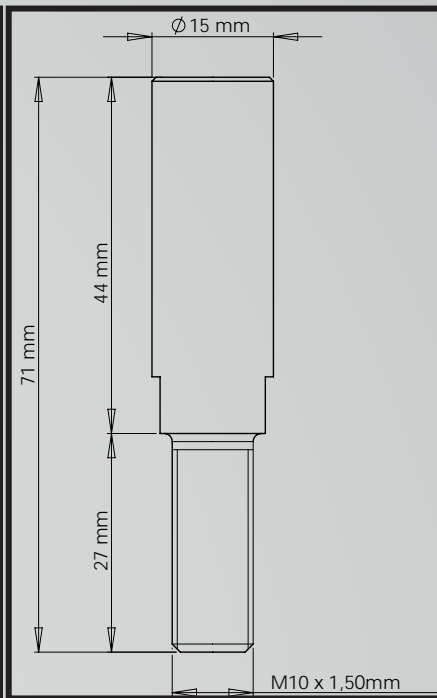

**2CP05300210000**

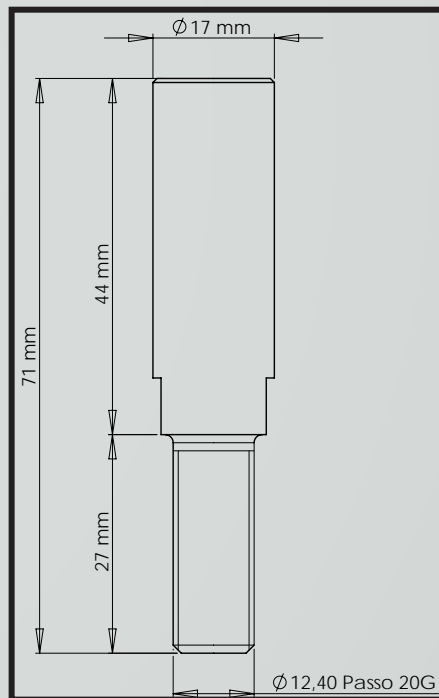

**2CP05300220000**

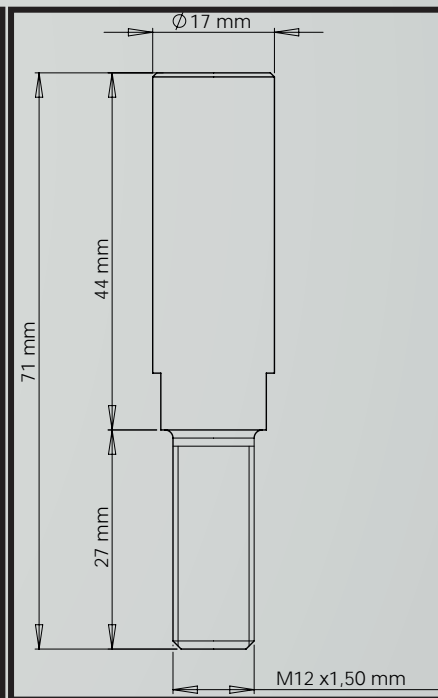

»Using only 6 models of Wheel Spacers with different bolts, is possible to configure your Wheel Spacer to all moto 4 models, accomplishing in a simple way adjust and personalize the Wheel Spacer to your needs.

»This innovation allows:

- Reduce the costs and space in stock
- More convenience for you and your clients

»Available in different colors.

»Utilizando apenas 6 modelos de alargadores e conjugando com diferentes pernos, é possível configurar o seu alargador para todos os modelos de motos, conseguindo de forma simples ajustar e personalizar o alargador às suas necessidades.

»Esta inovação permite:

- Redução de custos e espaço de stock
- Maior comodidade para si e seus clientes

»Disponível também em vários acabamentos.

# AVAILABLE SETS



| PERFIL MODEL | BOLT               | SPACERS KIT 45mm | SPACERS KIT 65mm | SPACERS KIT 100mm |
|--------------|--------------------|------------------|------------------|-------------------|
| A            | + 2CP05300150000 = | 2CP05200280***   | 2CP05200360***   | 2CP05200370***    |
| A            | + 2CP05300160000 = | 2CP05200290***   |                  |                   |
| A            | + 2CP05300170000 = | 2CP05200300***   |                  |                   |
| B            | + 2CP05300150000 = | 2CP05200310***   | 2CP05200390***   |                   |
| B            | + 2CP05300160000 = | 2CP05200320***   |                  |                   |
| B            | + 2CP05300170000 = | 2CP05200330***   |                  |                   |
| C            | + 2CP05300210000 = | 2CP05200340***   |                  |                   |
| D            | + 2CP05300150000 = | 2CP05200420***   | 2CP05200450***   |                   |
| C            | + 2CP05300150000 = | 2CP05200430***   |                  |                   |
| E            | + 2CP05300220000 = | 2CP05200440***   |                  |                   |
| F            | + 2CP05300220000 = | 2CP05200460***   |                  |                   |

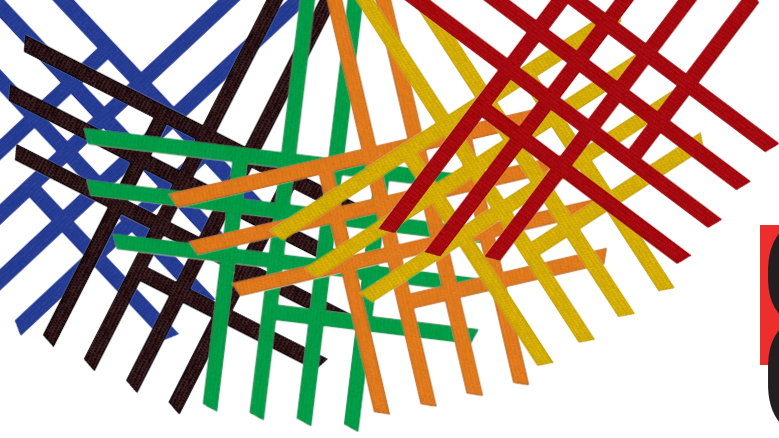

# RACING 86 BELTS

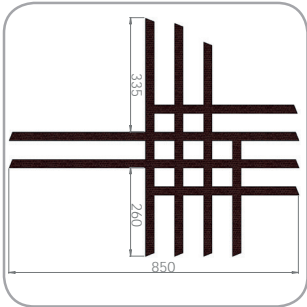

2CP1410001\*\*\*\*

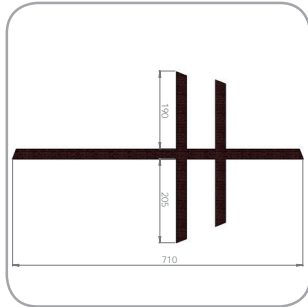

2CP1410002\*\*\*\*

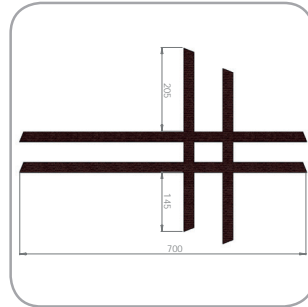

2CP1410003\*\*\*\*

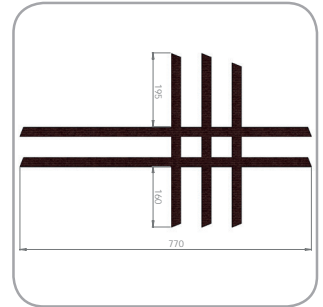

2CP1410004\*\*\*\*

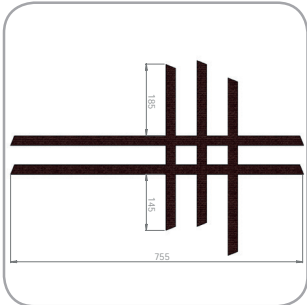

2CP1410005\*\*\*\*

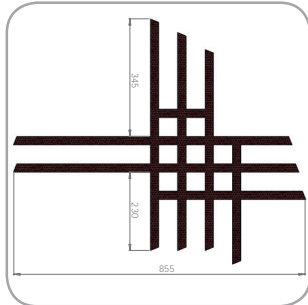

2CP1410006\*\*\*\*

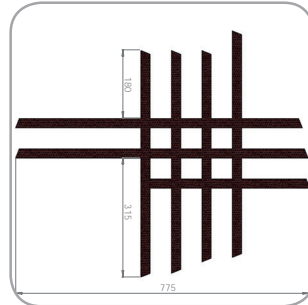

2CP1410007\*\*\*\*

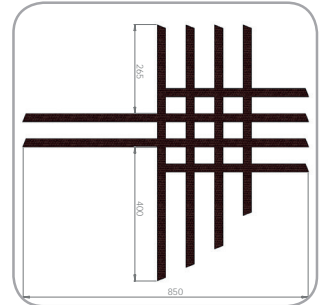

2CP1410008\*\*\*\*

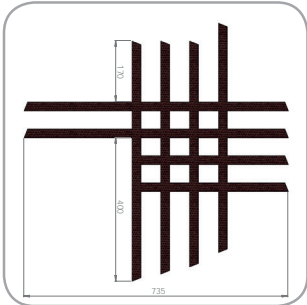

2CP1410009\*\*\*\*

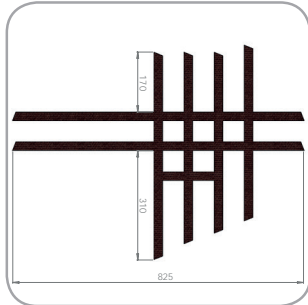

2CP1410010\*\*\*\*

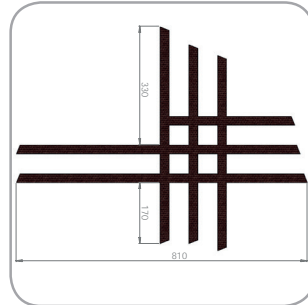

2CP1410011\*\*\*\*

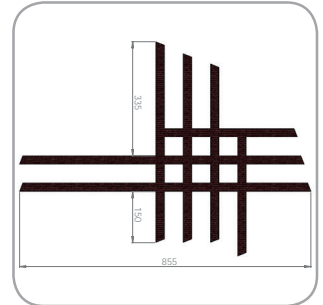

2CP1410012\*\*\*\*

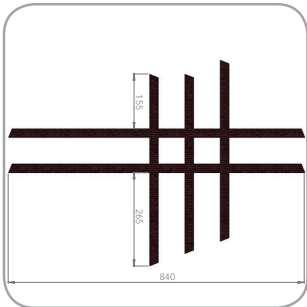

2CP1410013\*\*\*\*

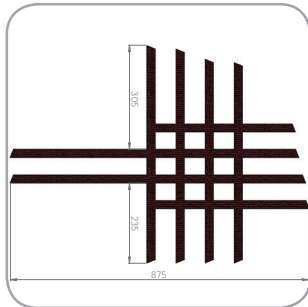

2CP1410014\*\*\*\*

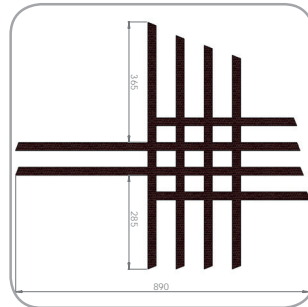

2CP1410015\*\*\*\*

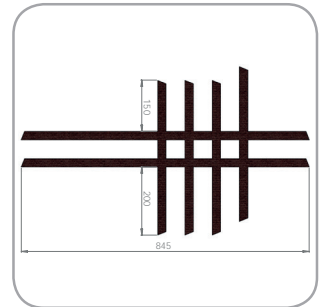

2CP1410016\*\*\*\*

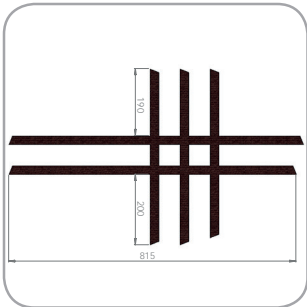

2CP1410017\*\*\*\*

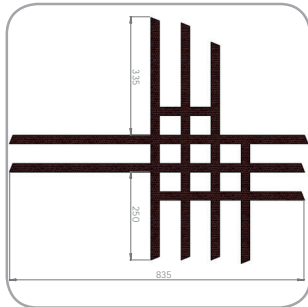

2CP1410018\*\*\*\*



2CP1410019\*\*\*\*

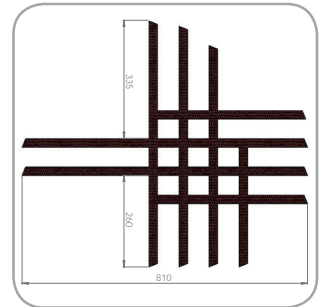

2CP1410020\*\*\*\*

» Replace the (\*\*\*\*) for the code of the desired color Example: Red Color 2CP0520028**0007**

» Substituir os (\*\*\*\*) pelo código de cor pretendida: Exemplo: para a cor vermelha 2CP0520028**0007**

- »0004  
 Black  
 Preto
- »0011  
 Blue  
 Azul
- »0007  
 Red  
 Vermelho
- »0008  
 Yellow  
 Amarelo
- »0010  
 Orange  
 Laranja
- »0009  
 Green  
 Verde

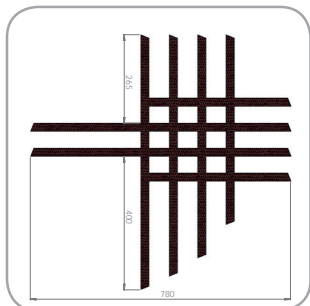

2CP1410021\*\*\*\*

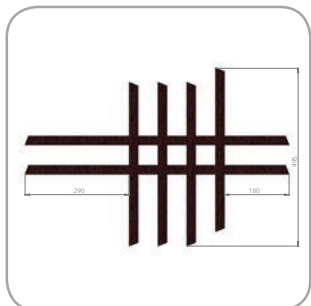

2CP1410022\*\*\*\*

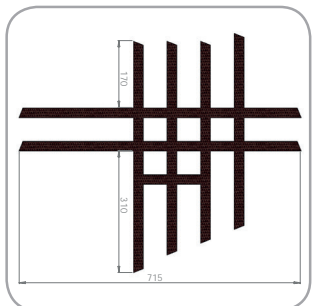

2CP1410023\*\*\*\*

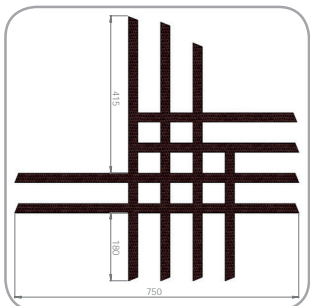

2CP1410024\*\*\*\*

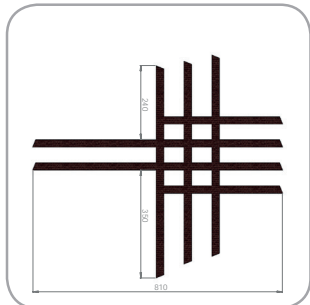

2CP1410025\*\*\*\*

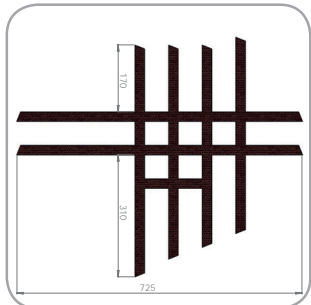

2CP1410026\*\*\*\*

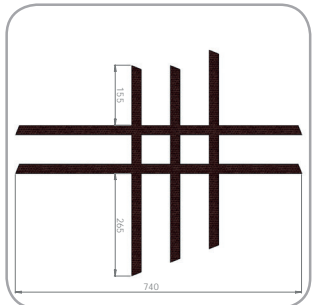

2CP1410027\*\*\*\*

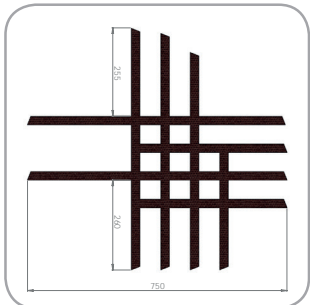

2CP1410028\*\*\*\*

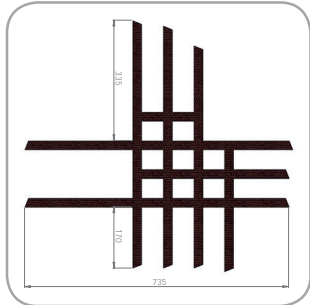

2CP1410029\*\*\*\*

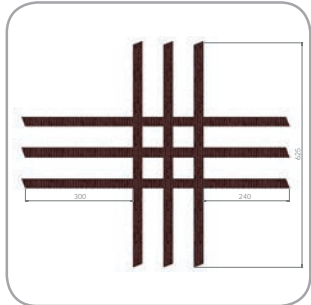

2CP1410030\*\*\*\*

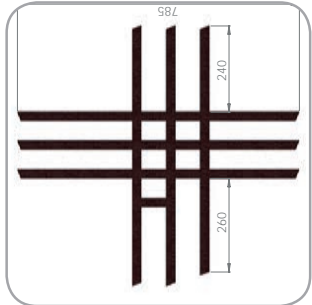

2CP1410031\*\*\*\*

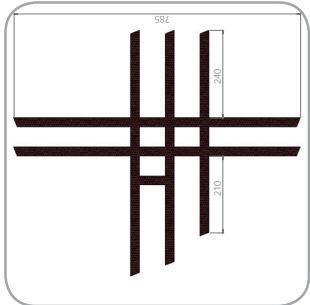

2CP1410032\*\*\*\*

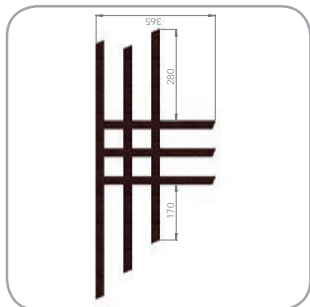

2CP1410033\*\*\*\*

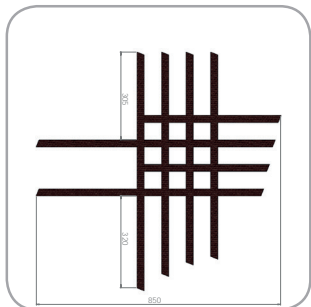

2CP1410034\*\*\*\*

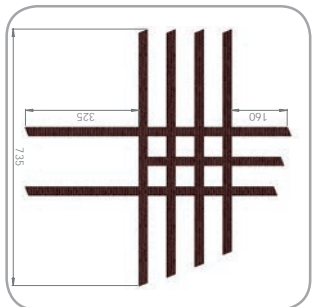

2CP1410035\*\*\*\*

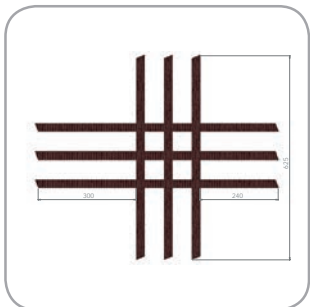

2CP1410037\*\*\*\*

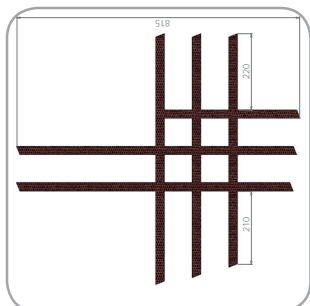

2CP1410038\*\*\*\*

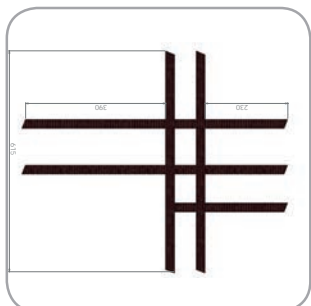

2CP1410039\*\*\*\*

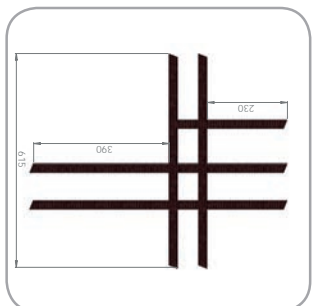

2CP1410043\*\*\*\*

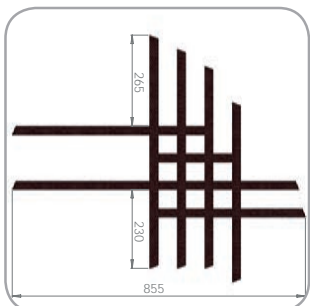

2CP1410044\*\*\*\*

» **Protect the important with CrossPro**

Besides the ATV and UTV protections, CrossPro bets on products that allow maximizing your safety.

Combining the knowledge of these equipments with the best materials, CrossPro offers a complete range of protections and accessories that will allow you to enjoy your moto.

Developed and built by skilled professionals, this is adequate protection to a customer who knows the importance of protecting his bike.

» **Protege o mais importante com Crosspro**

Além das protecções para o seu ATV e UTV, a CrossPro aposta em produtos que permitem maximizar a sua segurança.

Conjugando um vasto conhecimento sobre estes equipamentos e os melhores materiais, a CrossPro oferece uma gama completa de protecções e acessórios que lhe permitirão usufruir da melhor forma da sua moto.

Desenvolvida e construída por profissionais qualificados, esta é a protecção adequada a um cliente ciente da importância da protecção da sua moto.



**utility ATVs**  
**hard**  
**protections**



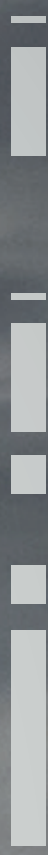

89



# 90

## ALUMINUM PROTECTION ATV

»Crosspro presents the most complete range of protections parts for your ATVs and UTVs.  
»Produced with 5mm thickness, Crosspro Protection parts protect every cm of your ATV/UTV.  
»All ATV parts interlocks with each other in order to give maximum stability, strength and protection

»A Crosspro apresenta a gama mais completa do mercado de protecções para ATVs e UTVs.  
»Produzidos com Alumínio de 5mm de espessura , as protecções Crosspro protegem cada cm do seu ATV/UTV.  
»Todas as protecções encaixam perfeitamente umas nas outras, por forma a proporcionar a maior estabilidade, protecção e resistência.

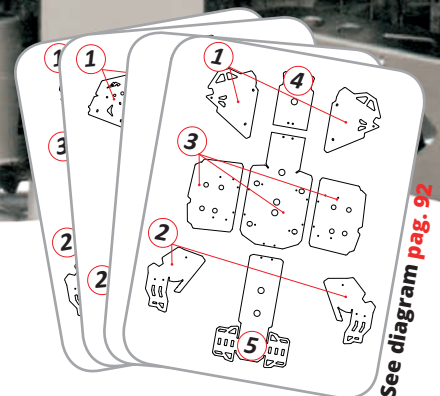

See diagram pag. 92

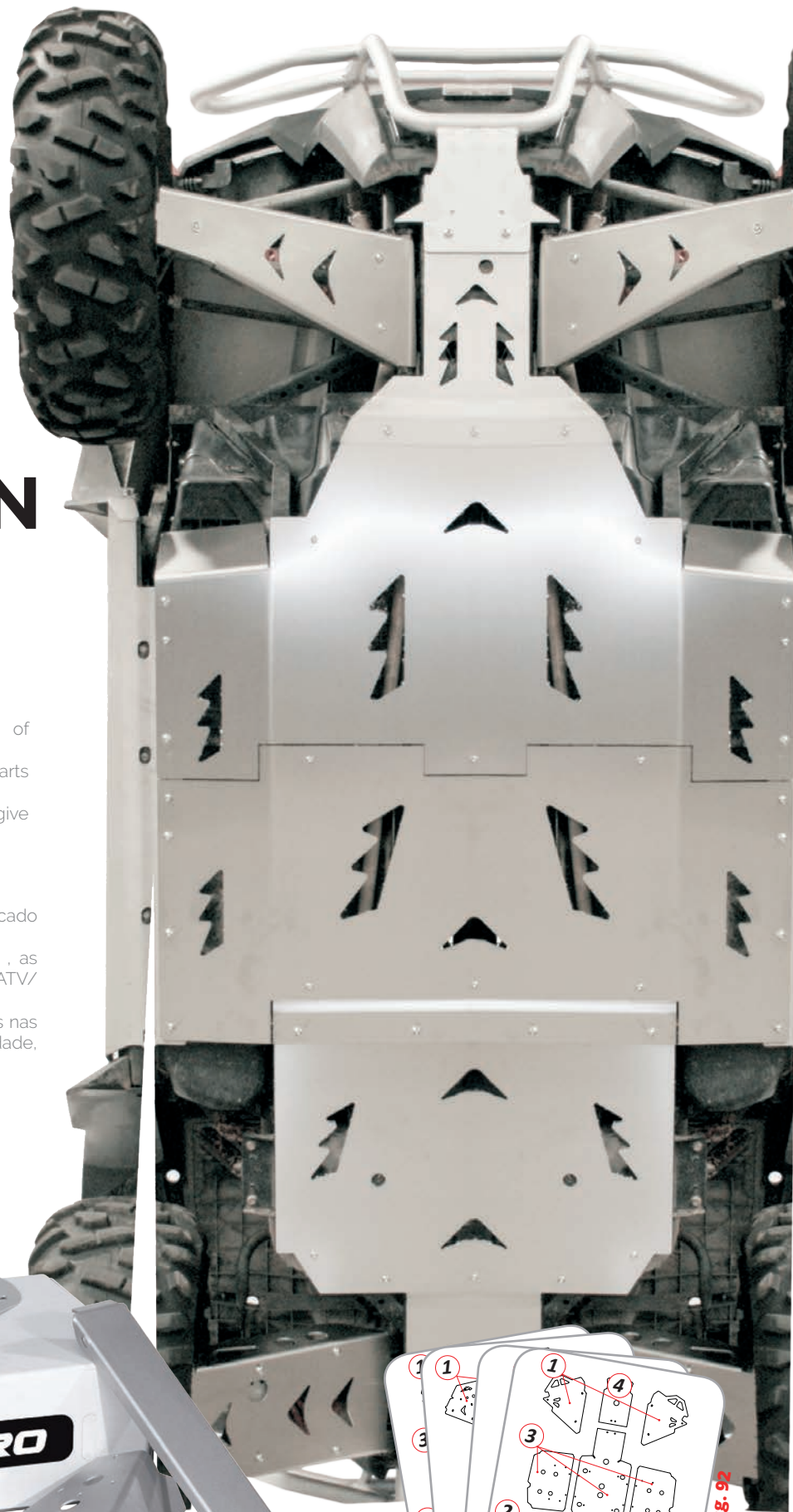



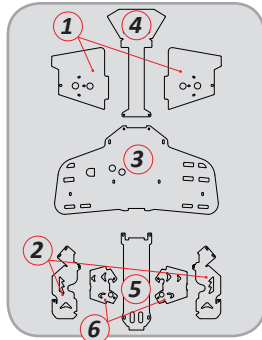

**2CP055035A00\***

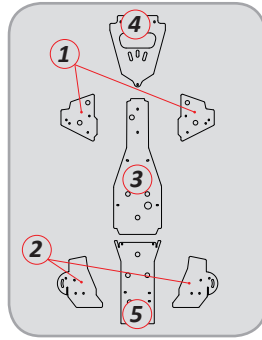

**2CP055003600\***

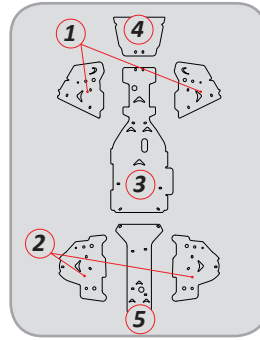

**2CP055003700\***

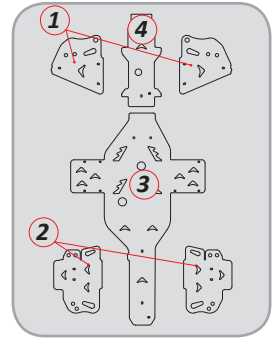

**2CP055003800\***

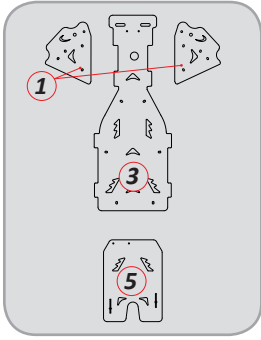

**2CP055003900\***

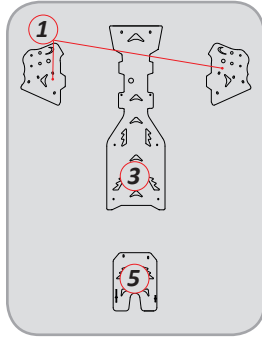

**2CP055004000\***

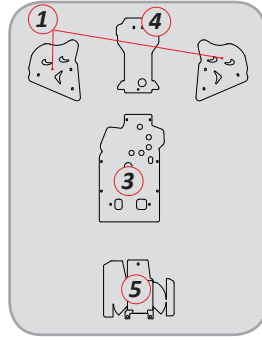

**2CP055004100\***

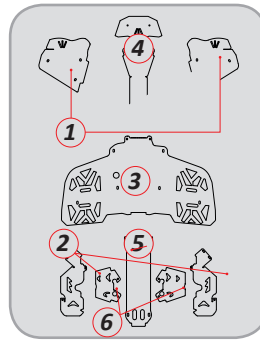

**2CP055042A00\***

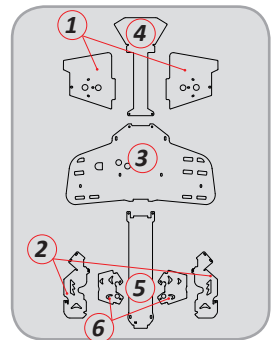

**2CP055043A00\***

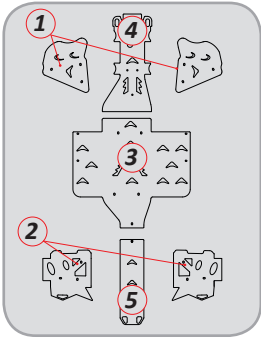

**2CP055004600\***

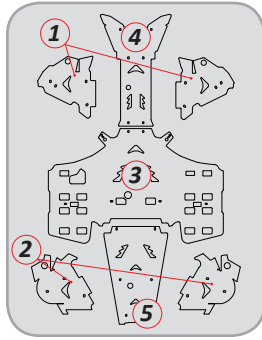

**2CP055004700\***

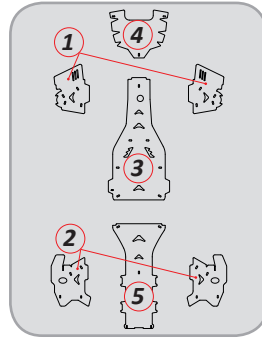

**2CP055004900\***

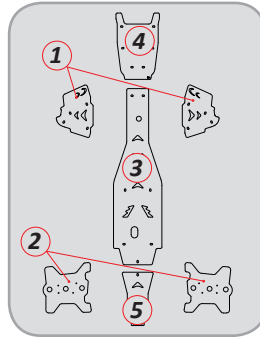

**2CP055005000\***

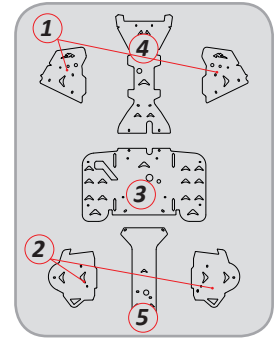

**2CP055005200\***

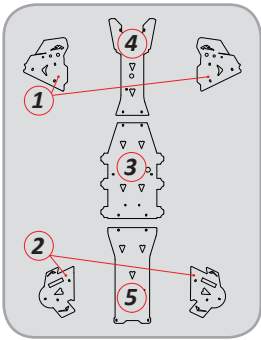

**2CP055005300\***

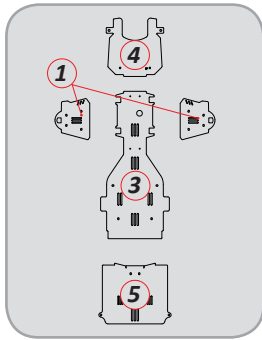

**2CP055005600\***

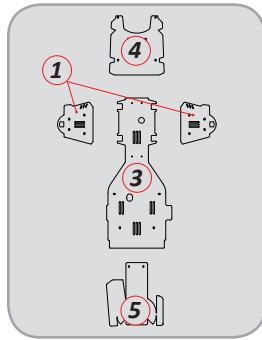

**2CP055005700\***

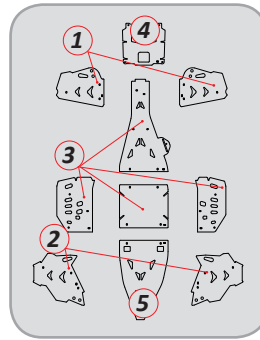

**2CP055006000\***

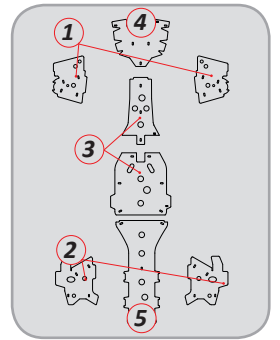

**2CP055006200\***

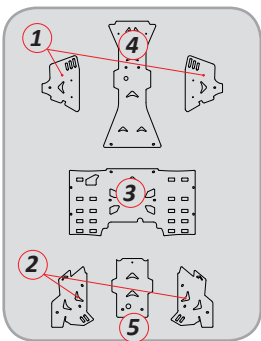

**2CP055007200\***

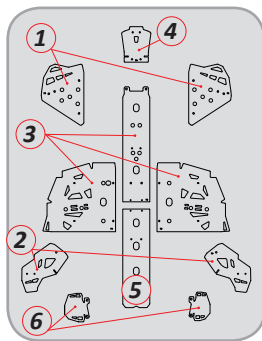

**2CP055007900\***

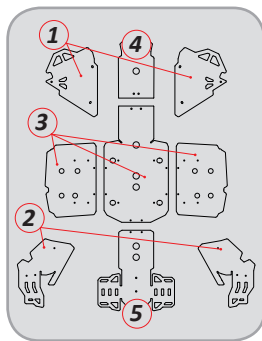

**2CP055008500\***

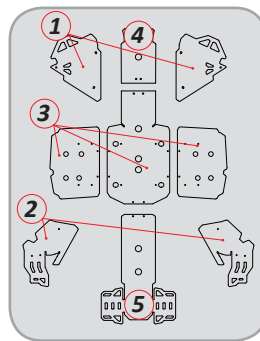

**2CP055008600\***

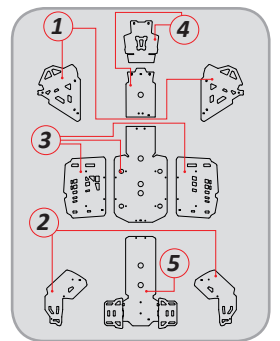

**2CP055009300\***

# DTC PROTECTION ATV



| CAN-AM                                   | COLOR    | COMPLET KIT    | (1)FRONT A-ARMS | (2)REAR A-ARMS | (3)CENTRAL CARTER | (4)FRONT CARTER | (5)REAR CARTER | (6)CARDAN      |
|--|----------|----------------|-----------------|----------------|-------------------|-----------------|----------------|----------------|
| 500/650/800 Outlander<br>(2006-2012)     | ● Black  | 2CP13900350300 | 2CP04500350300  | -              | 2CP14300350300    | 2CP14400350300  | 2CP14500350300 | -              |
|  | ● Blue   | -              | 2CP04500350400  | -              | -                 | -               | -              | -              |
|  | ● Red    | -              | 2CP04500350500  | -              | -                 | -               | -              | -              |
|  | ○ White  | -              | 2CP04500350600  | -              | -                 | -               | -              | -              |
|  | ● Yellow | -              | 2CP04500350700  | -              | -                 | -               | -              | -              |
| 500/650/800 Outlander MAX<br>(2006-2012) | ● Orange | -              | 2CP04500350800  | -              | -                 | -               | -              | -              |
|  | ● Black  | 2CP13900430300 | 2CP04500430300  | -              | 2CP14300430300    | 2CP14400430300  | 2CP14500430300 | -              |
|  | ● Blue   | -              | 2CP04500430400  | -              | -                 | -               | -              | -              |
|  | ● Red    | -              | 2CP04500430500  | -              | -                 | -               | -              | -              |
|  | ○ White  | -              | 2CP04500430600  | -              | -                 | -               | -              | -              |
| 1000 Outlander Maxx<br>(2013-2015)       | ● Yellow | -              | 2CP04500430700  | -              | -                 | -               | -              | -              |
|  | ● Orange | -              | 2CP04500430800  | -              | -                 | -               | -              | -              |
|  | ● Black  | 2CP13900860300 | 2CP04500860300  | 2CP11600860300 | 2CP14300860300    | 2CP14400420300  | 2CP14500420300 | -              |
|  | ● Blue   | -              | 2CP04500860400  | 2CP11600860400 | -                 | -               | -              | -              |
|  | ● Red    | -              | 2CP04500860500  | 2CP11600860500 | -                 | -               | -              | -              |
| 1000 Outlander X MR<br>(2013-2015)       | ○ White  | -              | 2CP04500860600  | 2CP11600860600 | -                 | -               | -              | -              |
|  | ● Yellow | -              | 2CP04500860700  | 2CP11600860700 | -                 | -               | -              | -              |
|  | ● Orange | -              | 2CP04500860800  | 2CP11600860800 | -                 | -               | -              | -              |
|  | ● Black  | 2CP13900850300 | 2CP04500850300  | 2CP11600850300 | 2CP14300850300    | 2CP14400850300  | 2CP14500850300 | -              |
|  | ● Blue   | -              | 2CP04500850400  | 2CP11600850400 | -                 | -               | -              | -              |
| 1000 Renegade<br>(2012-2015)             | ● Red    | -              | 2CP04500850500  | 2CP11600850500 | -                 | -               | -              | -              |
|  | ○ White  | -              | 2CP04500850600  | 2CP11600850600 | -                 | -               | -              | -              |
|  | ● Yellow | -              | 2CP04500850700  | 2CP11600850700 | -                 | -               | -              | -              |
|  | ● Orange | -              | 2CP04500850800  | 2CP11600850800 | -                 | -               | -              | -              |
|  | ● Black  | 2CP13900790300 | 2CP04500790300  | 2CP11600790300 | 2CP14300790300    | 2CP14400790300  | 2CP14500790300 | 2CP14600790300 |
| 1000 Renegade<br>(2012-2015)             | ● Blue   | -              | 2CP04500790400  | 2CP11600790400 | -                 | -               | -              | 2CP14600790400 |
|  | ● Red    | -              | 2CP04500790500  | 2CP11600790500 | -                 | -               | -              | 2CP14600790500 |
|  | ○ White  | -              | 2CP04500790600  | 2CP11600790600 | -                 | -               | -              | 2CP14600790600 |
|  | ● Yellow | -              | 2CP04500790700  | 2CP11600790700 | -                 | -               | -              | 2CP14600790700 |
|  | ● Orange | -              | 2CP04500790800  | 2CP11600790800 | -                 | -               | -              | 2CP14600790800 |

»Crosspro presents the most complete range of protections parts for your ATVs and UTVs.  
 »Produced with DTC 8mm thickness, Crosspro Protection parts protect every cm of your ATV/UTV.  
 »All ATV parts interlocks with each other in order to give maximum stability, strength and protection

»A Crosspro apresenta a gama mais completa do mercado de protecções para ATVs e UTVs.  
 »Produzidos em DTC de 8mm de espessura, as protecções Crosspro protegem cada cm do seu ATV/UTV.  
 »Todas as protecções encaixam perfeitamente umas nas outras, por forma a proporcionar a maior estabilidade, protecção e resistência.

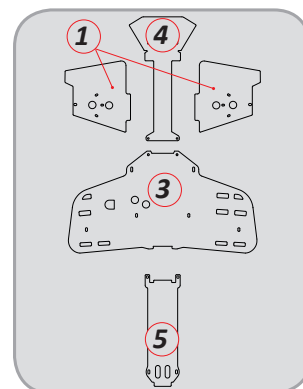

**2CP13900350\*\*\***

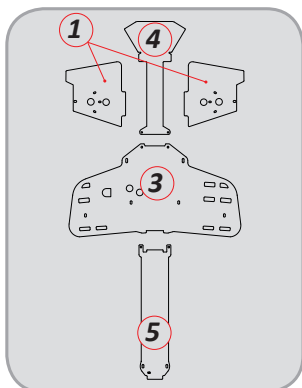

**2CP13900430\*\*\***

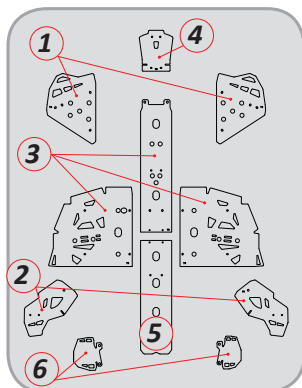

**2CP13900790\*\*\***

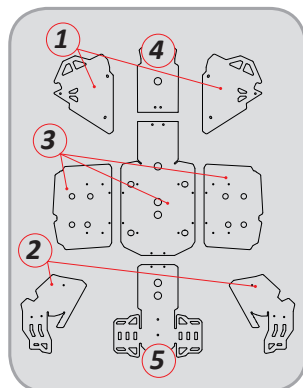

**2CP13900850\*\*\***

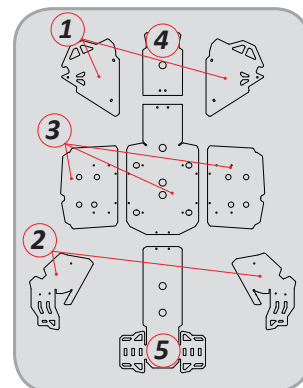

**2CP13900860\*\*\***

# 94



»The Bumper of CrossPro ATV's / UTV's strength combined with design  
 »Produced in T6061 aluminum with 35mm tubing  
 »The best choice

»Os Pára-choques da CrossPro para ATV's / UTV's combinam resistência com design  
 »Produzidos em alumínio T6061, com tubo de 35mm  
 »A melhor escolha

# ATV BUMPERS



| GOES                         |       | ● ICE MATTE    | ● BLACK        | ● TEXTURED BLACK |
|------------------------------|-------|----------------|----------------|------------------|
| 520 Max<br>(all years)       | FRONT | 2CP06200530001 | 2CP06200530004 | 2CP06200530005   |
|                              | REAR  | 2CP0630530001  | 2CP0630530004  | 2CP0630530005    |
| HONDA                        |       | ● ICE MATTE    | ● BLACK        | ● TEXTURED BLACK |
| 680 Rincon<br>(2008-2014)    | FRONT | 2CP06200500001 | 2CP06200500004 | 2CP06200500005   |
|                              | REAR  | 2CP06300500001 | 2CP06300500004 | 2CP06300500005   |
| KAWASAKI                     |       | ● ICE MATTE    | ● BLACK        | ● TEXTURED BLACK |
| 750 KVF 4x4<br>(2008-2011)   | FRONT | 2CP06200520001 | 2CP06200520004 | 2CP06200520005   |
|                              | REAR  | 2CP06300520001 | 2CP06300520004 | 2CP06300520005   |
| KYMCO                        |       | ● ICE MATTE    | ● BLACK        | ● TEXTURED BLACK |
| 500 MXU<br>(2009-2010)       | FRONT | 2CP06200390001 | 2CP06200390004 | 2CP06200390005   |
|                              | REAR  | 2CP06300390001 | 2CP06300390004 | 2CP06300390005   |
| POLARIS                      |       | ● ICE MATTE    | ● BLACK        | ● TEXTURED BLACK |
| 700/800 Sportsman TWIN       | FRONT | 2CP06200380001 | 2CP06200380004 | 2CP06200380005   |
|                              | REAR  | 2CP06300380001 | 2CP06300380004 | 2CP06300380005   |
| TGB                          |       | ● ICE MATTE    | ● BLACK        | ● TEXTURED BLACK |
| 425 Blade<br>(2008)          | FRONT | 2CP06200570001 | 2CP06200570004 | 2CP06200570005   |
|                              | REAR  | 2CP06300570001 | 2CP06300570004 | 2CP06300570005   |
| SUZUKI                       |       | ● ICE MATTE    | ● BLACK        | ● TEXTURED BLACK |
| 450 King Quad<br>(2007-2010) | FRONT | 2CP06200490001 | 2CP06200490004 | 2CP06200490005   |
|                              | REAR  | 2CP06300490001 | 2CP06300490004 | 2CP06300490005   |
| 700 King Quad<br>(2006-2007) | FRONT | 2CP06200490001 | 2CP06200490004 | 2CP06200490005   |
|                              | REAR  | 2CP06300490001 | 2CP06300490004 | 2CP06300490005   |
| 750 King Quad                | FRONT | 2CP06200490001 | 2CP06200490004 | 2CP06200490005   |
|                              | REAR  | 2CP06300490001 | 2CP06300490004 | 2CP06300490005   |
| YAMAHA                       |       | ● ICE MATTE    | ● BLACK        | ● TEXTURED BLACK |
| 700 Grizzly<br>(2007-2013)   | FRONT | 2CP06200470001 | 2CP06200470004 | 2CP06200470005   |
|                              | REAR  | 2CP06300470001 | 2CP06300470004 | 2CP06300470005   |





**Europe**

- Austria
- Belgium
- Cyprus
- Czech Republic
- Denmark
- Estonia
- Finland
- France
- Germany
- Greece
- Holland
- Hungary
- India
- Italy
- Latvia
- Lithuania
- Luxembourg
- Norway
- Poland
- Portugal
- Romania
- Russia
- Slovakia
- Slovenia
- Spain
- Sweden
- Switzerland
- United Kingdom

**Asia**

- Dubai
- Iran
- Israel
- Japan
- Kwait
- Malaysia
- Philippines
- Rep. Coreia
- Russia
- Singapore
- Thailand

**AMERICA**

- Argentina
- Canada
- Chile
- USA
- Mexico

**OCEANIA**

- Australia
- New Zealand

**AFRICA**

- South Africa
- Angola
- Cape Verde
- Morocco



97



The consumer demand, the ease with which it has access to information force a constant search for innovative products as well as excellence by CROSSPRO.

Anticipating all the demands of the market, as well as the challenges envisioned, CROSSPRO has increased its product range throughout its existence, leading to a presence in more than 50 countries. Internationalization exposed exports, accounting for about 95% of CROSSPRO's current production.

Made by CROSSPRO

A exigência do consumidor, a facilidade com que o mesmo tem acesso à informação obriga a uma constante procura por produtos inovadores assim como pela excelência por parte da CROSSPRO.

Antevendo todas as exigências a que o mercado obriga, assim como os desafios vislumbrados, a CROSSPRO ao longo da sua existência aumentou a sua gama de produtos, levando a uma presença em mais de 50 países. A internacionalização exponenciou as exportações, representando estas cerca de 95% da produção da realizada actualmente pela CROSSPRO.

Made by CROSSPRO

CrossPro  
around the  
world



Painting is done through lacquering, which is an electrostatic painting process performed with powder paints.

In the lacquering process, the guards can acquire different colors, we have 9 different colors for your guards.

This process as well as the treatment to which the parts are subjected, reinforces the corrosion protection and maximizes the adhesion and duration of the paint and initial color.

A simple, effective and resistant process

A pintura é realizada através da lacagem, que consiste num processo de pintura eletrostático executado com tintas em pó.

Este processo bem como o tratamento a que as peças são sujeitas, reforça a protecção anticorrosiva e maximiza a adesão e duração da tinta.

No nosso processo de lacagem dispomos de 9 cores diferentes para as suas protecções.

Um processo simples, eficaz e resistente

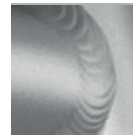

Ice Matte



Polish

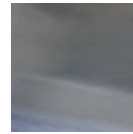

Neutral



Black  
*ral: 9005*

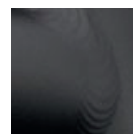

Textured Black  
*ral: 9005 text*



White  
*ral: 9110*

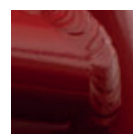

Red  
*ral: 3020*



Yellow  
*ral: 1021*



Green  
*ral: 6018*



Orange  
*ral: 2004*



Blue  
*ral: 5002*



Indicative weights  
Pesos indicativos

# 99

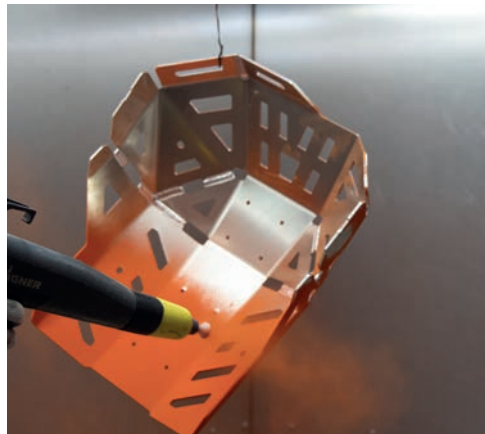
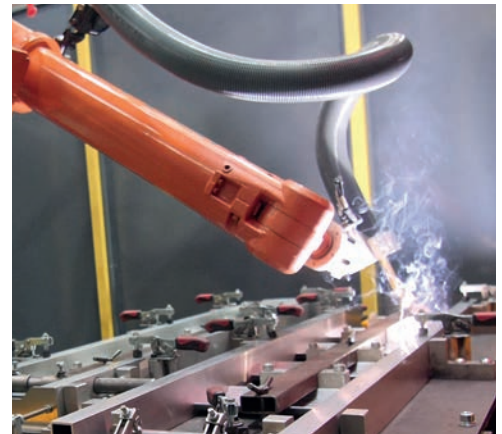
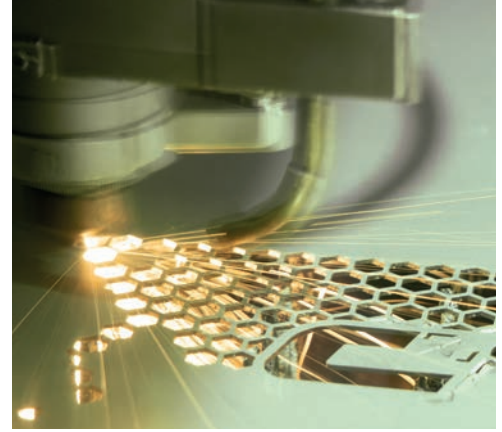
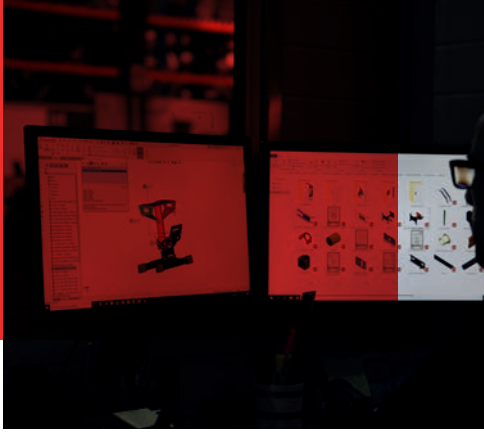

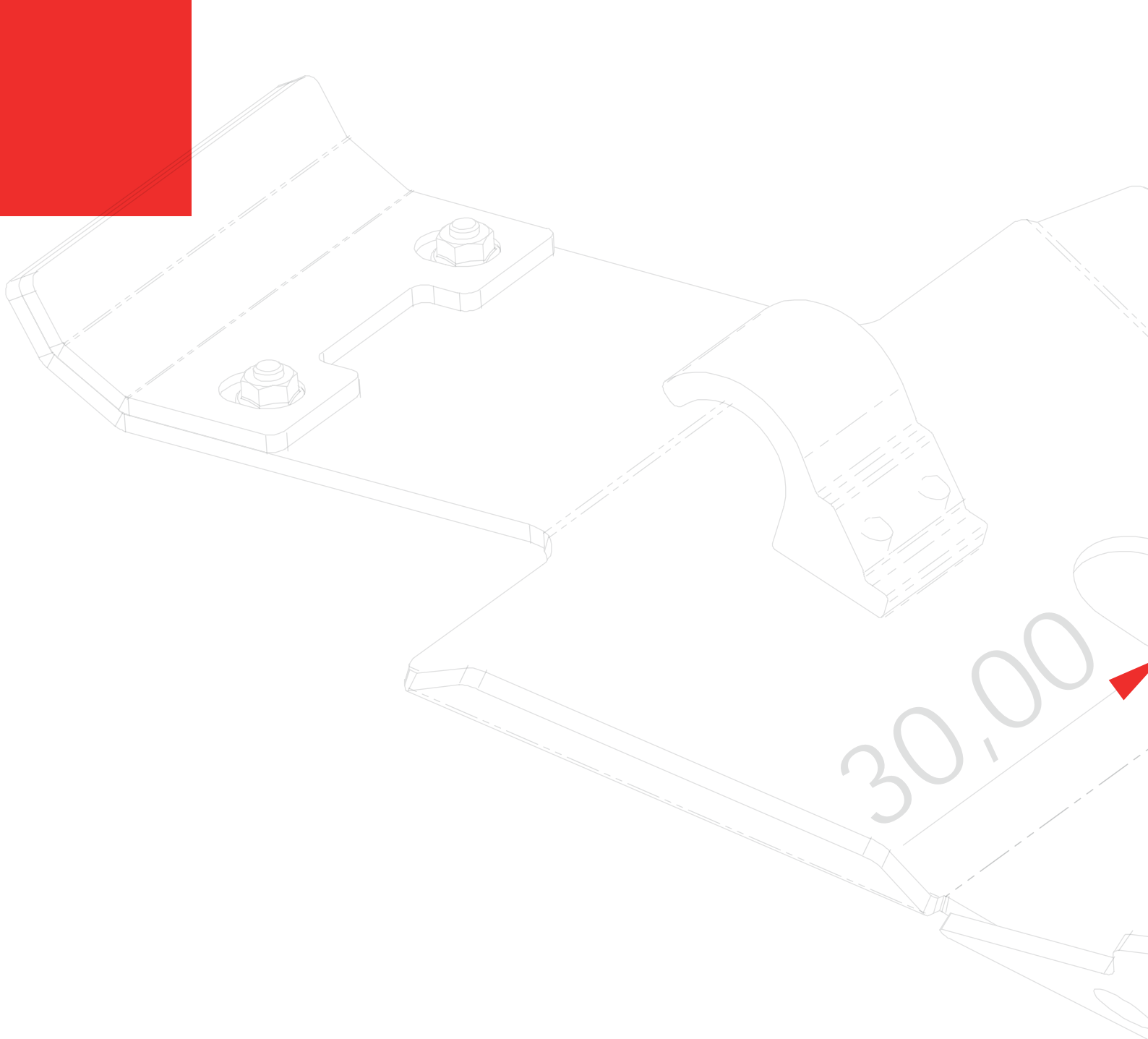

**CROSSPRO**  
PROTECTION PARTS

Zona Industrial do Paraimo, Lote 45  
3780-524 - Sangalhos | Anadia | Portugal

Gps: 40°28 '31.0"N 8°28 '39.5"W

Phone: +351 234 629 044  
www.crosspro.pt  
E-mail: geral@crosspro.pt

2CPCATOR20



Management  
System  
ISO 9001:2015



www.tuv.com  
ID 910507726